

# JUMO diraTRON 104/108/116/132

Compact controller



Operating Manual



70211000T90Z001K000

V8.00/EN/00688648/2023-05-23



<b>1</b>	<b>Introduction</b>	<b>7</b>
1.1	Safety information	7
1.2	Intended use	8
1.3	Qualification of personnel	8
1.4	Acceptance of goods, storage, and transport	8
1.4.1	Checking the delivery	8
1.4.2	Important information about storage and transport	8
1.4.3	Returning goods	8
1.4.4	Disposal	9
1.5	Identifying the device version	10
1.5.1	Nameplate	10
1.5.2	Order details	11
1.5.3	Scope of delivery	12
1.5.4	Accessories	12
1.6	Brief description	13
1.7	Block diagram	13
1.8	Device types	14
<b>2</b>	<b>Mounting</b>	<b>15</b>
2.1	Installation instructions	15
2.2	Cleaning	15
2.3	Dimensions	16
2.4	DIN rail installation	20
2.5	Panel mounting	21
<b>3</b>	<b>Electrical connection</b>	<b>23</b>
3.1	Installation notes	23
3.2	Connection elements	24
3.3	Connection diagram	26
3.3.1	Analog input	26
3.3.2	Digital inputs	26
3.3.3	Analog output	27
3.3.4	Digital outputs	27
3.3.5	RS485 interface	28
3.3.6	Voltage supply	28
3.4	Galvanic isolation	28
<b>4</b>	<b>Operation</b>	<b>29</b>
4.1	Display and control elements	29
4.2	Language selection	31
4.3	Basic status	31
4.4	Manual mode	32
4.5	Operating levels	32

---

# Contents

---

4.6	Level inhibit . . . . .	34
4.7	User level . . . . .	34
4.8	Device information . . . . .	34
4.8.1	Versions . . . . .	35
4.8.2	Service . . . . .	35
4.9	Error messages . . . . .	35
<b>5</b>	<b>Program editor . . . . .</b>	<b>37</b>
5.1	Program administration . . . . .	37
5.2	Program simulation (setup only) . . . . .	39
<b>6</b>	<b>Parameterization . . . . .</b>	<b>41</b>
6.1	Parameter blocks . . . . .	41
6.2	Controller types . . . . .	43
<b>7</b>	<b>Configuration . . . . .</b>	<b>45</b>
7.1	Identification (setup only) . . . . .	45
7.2	Selectors . . . . .	45
7.3	System data . . . . .	48
7.4	Display/operation . . . . .	48
7.5	Analog input . . . . .	50
7.5.1	Fine adjustment . . . . .	53
7.6	Analog output . . . . .	55
7.7	Digital inputs . . . . .	56
7.8	Digital outputs . . . . .	57
7.9	Controller . . . . .	57
7.9.1	Controller configuration . . . . .	57
7.9.2	Controller input . . . . .	58
7.9.3	Autotuning . . . . .	59
7.9.4	Control loop monitoring (setup only) . . . . .	62
7.9.5	Output level monitoring (setup only) . . . . .	64
7.9.6	Setpoint values . . . . .	67
7.9.7	Ramp function . . . . .	67
7.10	Program controller . . . . .	68
7.11	Timer . . . . .	70
7.12	Limit value monitoring functions . . . . .	71
7.12.1	Alarm functions and switching behavior . . . . .	74
7.13	Serial interface . . . . .	76
7.14	Ethernet interface . . . . .	76

---

<b>8</b>	<b>Configuration - setup only</b> .....	<b>77</b>
8.1	ST code .....	77
8.2	Digital control signals .....	78
8.3	User level .....	79
8.4	Flags .....	80
8.5	Math/Logic .....	81
8.6	Service .....	82
8.7	Ext. analog inputs .....	82
8.8	Ext. digital inputs .....	83
8.9	Customized linearization .....	83
<b>9</b>	<b>Online parameter (setup only)</b> .....	<b>85</b>
9.1	Fine adjustment .....	85
9.2	Approval of extra codes .....	85
9.3	Calibrate/test .....	86
9.4	Additional process values for online data .....	90
<b>10</b>	<b>Start-up parameter (setup only)</b> .....	<b>91</b>
10.1	Process values .....	91
10.2	Display .....	92
<b>11</b>	<b>Technical data</b> .....	<b>95</b>
11.1	Analog input .....	95
11.2	Digital inputs .....	97
11.3	Analog output .....	97
11.4	Digital outputs .....	98
11.5	Interfaces .....	98
11.6	Display .....	98
11.7	Electrical data .....	99
11.8	Environmental influences .....	99
11.9	Case .....	100
11.10	Approvals and approval marks .....	100
<b>12</b>	<b>China RoHS</b> .....	<b>101</b>

---

# Contents

---

---

## 1.1 Safety information

### General

This manual contains information that must be observed in the interest of your own safety and to avoid material damage. This information is supported by symbols which are used in this manual as indicated.

Please read this manual before starting up the device. Store this manual in a place that is accessible to all users at all times.

If difficulties occur during startup, please do not intervene in any way that could jeopardize your warranty rights!

### Warning symbols



#### WARNING!

This symbol in connection with the signal word indicates that **personal injury** may occur if the respective precautionary measures are not carried out.



#### CAUTION!

This symbol in connection with the signal word indicates that **material damage or data loss** will occur if the respective precautionary measures are not taken.



#### CAUTION!

This symbol indicates that **components could be destroyed** by electrostatic discharge (ESD = Electro Static Discharge) if the respective cautionary measures are not taken.

Only use the ESD packages intended for this purpose to return device inserts, assembly groups, or assembly components.



#### READ THE DOCUMENTATION!

This symbol, which is attached to the device, indicates that the associated **documentation for the device** must be **observed**. This is necessary to identify the nature of the potential hazard, and to take measures to prevent it.

### Note symbols



#### NOTE!

This symbol refers to **important information** about the product, its handling, or additional benefits.



#### REFERENCE!

This symbol refers to **additional information** in other sections, chapters, or other manuals.



#### FURTHER INFORMATION!

This symbol is used in tables and indicates that **further information** is provided after the table.



#### DISPOSAL!

At the end of its service life, the device and any batteries present do not belong in the trash! Please ensure that they are **disposed of** properly and in an **environmentally friendly** manner.

# 1 Introduction

---

## 1.2 Intended use

The device is designed for use in an industrial environment as specified in the technical data. Other uses beyond those defined are not viewed as intended uses.

The device has been manufactured in compliance with applicable standards and directives as well as the applicable safety regulations. Nevertheless, improper use may lead to personal injury or material damage.

To avoid danger, only use the device:

- For the intended use
- When in good order and condition
- When taking the technical documentation provided into account

Risks resulting from the application may arise, e.g. as the result of missing safety provisions or wrong settings, even when the device is used properly and as intended.

## 1.3 Qualification of personnel

This document contains the necessary information for the intended use of the device to which it relates. It is intended for staff with technical qualifications who have been specially trained and have the appropriate knowledge in the field of automation technology.

The appropriate level of knowledge and the technically fault-free implementation of the safety information and warnings contained in the technical documentation provided are prerequisites for risk-free mounting, installation, and startup as well as for ensuring safety when operating the described modules. Only qualified personnel have the required specialist knowledge to correctly interpret and implement the safety information and warnings contained in this document in specific situations.

## 1.4 Acceptance of goods, storage, and transport

### 1.4.1 Checking the delivery

- Ensure that the packaging and its contents are undamaged.
- Check the delivery for completeness against the packing slip and order details.
- Inform the supplier immediately if there is any damage.
- Store damaged parts until clarification is received from the supplier.

### 1.4.2 Important information about storage and transport

- Store the device in a dry, clean environment. Observe the admissible ambient conditions (see "Technical data")
- Protect the device from shock during transport
- The original packaging provides optimum protection for storage and transport

### 1.4.3 Returning goods

If repairs are needed, return the complete device in clean condition.

Use the original packaging to return goods.

#### Accompanying letter for repair

Please include the completed accompanying letter for repair when returning goods.

Do not forget to state the following:

- Description of the application and
- Description of the error that has occurred



The accompanying letter for repair (supplementary sheet for product returns) can be downloaded online from the manufacturer's website:

<http://productreturn.jumo.info>

## Protection against electrostatic discharge (ESD)

(ESD = electrostatic discharge)

To prevent damage due to ESD, electronic modules or components must be handled, packaged, and stored in an ESD-protected environment. Measures that protect against electrostatic discharge and electric fields are described in DIN EN 61340-5-1 and DIN EN 61340-5-2 "Protection of electronic devices from electrostatic phenomena".

When sending back electronic modules or components, please note the following:

- Pack sensitive components only in an environment providing protection against ESD. Workspaces such as this divert electrostatic charges to ground in a controlled manner and prevent static charges due to friction.
- Use only packaging intended specifically for ESD-sensitive modules/components. These must consist of conductive plastics.

No liability can be assumed for damage caused by ESD.



### CAUTION!

**Electrostatic charges occur in non-ESD-protected environments.**

Electrostatic discharges can damage modules or components.

- ▶ For transport purposes, use only the ESD packaging provided.
- 

## 1.4.4 Disposal

### Disposing of the device



#### DISPOSAL!

Devices and/or replaced parts should not be placed in the refuse bin at the end of their service life as they consist of materials that can be recycled by specialist recycling plants.

Dispose of the device and the packaging material in a proper and environmentally friendly manner.

For this purpose, observe the country-specific laws and regulations for waste treatment and disposal.

---

### Disposing of the packaging material

The entire packaging material (cardboard packaging, inserts, plastic film, and plastic bags) is fully recyclable.

# 1 Introduction

---

## 1.5 Identifying the device version

### 1.5.1 Nameplate

The nameplate is affixed to the housing.

#### Contents

The nameplate contains important information. This includes:

Description	Designation on the nameplate	Example
Device type	Typ	702114/81-4356-25/214
Part no.	TN	00123456
Serial number	F-Nr.	0070033801217480006
Voltage supply	-	AC/DC 20 to 30 V, 48 to 63 Hz

#### Device type (Typ)

Compare the specifications on the nameplate with the order.

Identify the supplied device version using the order details (order code).

#### Part no. (TN)

The part no. uniquely identifies an article in the catalog. It is important for communication between the customer and the sales department.

#### Serial number (F-Nr.)

The serial number indicates, among other things, the date of manufacture (year/week).

Example: F-no. = 00700338012**1748**0006

The characters in question are digits 12, 13, 14, and 15 (from the left).

Thus the device was produced in calendar week 48 of 2017.

#### MAC address

For a device with Ethernet interface, the MAC address is indicated on the nameplate.

## 1.5.2 Order details

	<b>(1) Basic type</b>
702110	<b>Type 702110</b> (format 132: 48 x 24 mm) 1 analog input, 2 digital inputs (digital input 1, alternative to logic output), 1 relay (N/O contact), 1 logic output 0/14 V (alternative to digital input 1) incl. timer, ramp function, and program function
702111	<b>Type 702111</b> (format 116: 48 x 48 mm) 1 analog input, 2 digital inputs (digital input 1, alternative to logic output), 2 relays (N/O contact), 1 logic output 0/14 V (alternative to digital input 1) incl. timer, ramp function, and program function
702112	<b>Type 702112</b> (format 108H: 48 x 96 mm) 1 analog input, 2 digital inputs (digital input 1, alternative to logic output), 2 relays (N/O contact), 1 logic output 0/14 V (alternative to digital input 1) incl. timer, ramp function, and program function
702113	<b>Type 702113</b> (format 108Q: 96 x 48 mm) 1 analog input, 2 digital inputs (digital input 1, alternative to logic output), 2 relays (N/O contact), 1 logic output 0/14 V (alternative to digital input 1) incl. timer, ramp function, and program function
702114	<b>Type 702114</b> (format 104: 96 x 96 mm) 1 analog input, 2 digital inputs (digital input 1, alternative to logic output), 2 relays (N/O contact), 1 logic output 0/14 V (alternative to digital input 1) incl. timer, ramp function, and program function
	<b>(2) Version</b>
8	Standard with default settings <sup>a</sup>
9	Customer-specific configuration (specifications in plain text)
	<b>(3) Option 1<sup>b</sup></b>
0	Not used
1	1 relay (N/O contact) (only for type 702111)
2	1 logic output 0/14 V (only for types 702111, 702112, 702113, 702114)
4	1 RS485 interface (Modbus-RTU)
	<b>(4) Option 2<sup>b</sup></b>
0	Not used
1	1 relay (N/O contact)
2	1 logic output 0/14 V
3	1 analog output
7	1 Ethernet interface (Modbus-TCP, Modbus-RTU/ASCII via TCP/IP; only for types 702112, 702113, 702114); <b>option 1 does not apply</b>
	<b>(5) Option 3<sup>b</sup></b> (only for types 702112, 702113, 702114)
0	Not used
1	1 relay (N/O contact)
2	1 logic output 0/14 V
5	1 PhotoMOS <sup>®</sup> relay <sup>c</sup>

# 1 Introduction

<b>(6) Option 4<sup>b</sup></b> (only for types 702112, 702113, 702114)	
0	Not used
1	1 relay (N/O contact)
2	1 logic output 0/14 V
5	1 PhotoMOS <sup>®</sup> relay <sup>c</sup>
6	1 relay (N/O contact) with longer contact life
<b>(7) Voltage supply</b>	
23	AC 110 to 240 V +10/-15 %, 48 to 63 Hz
25	AC/DC 20 to 30 V, 48 to 63 Hz
<b>(8) Extra codes</b>	
000	Without extra code
062	With DNV GL approval <sup>d</sup>
049	With BV approval <sup>d</sup>
214	Math and logic module
221	Structured text

<sup>a</sup> The language of the device texts can be adjusted (German, English, French, Spanish).

<sup>b</sup> The options cannot be retrofitted! Please consider options when ordering.

<sup>c</sup> PhotoMOS is a registered trademark of Panasonic Corporation.

<sup>d</sup> Can only be ordered for type 702111 with power supply AC/DC 20 to 30 V (approval only applies for operation with DC 20 to 30 V) and type 702114 with power supply AC 110 to 240 V; not in combination with Ethernet interface. The approval only applies to panel mounting.

<b>(1)</b>	<b>(2)</b>	<b>(3)</b>	<b>(4)</b>	<b>(5)</b>	<b>(6)</b>	<b>(7)</b>	<b>(8)</b>	
□	□	□	□	□	□	□	□	□
/ - / - / , ... <sup>a</sup>								
Order code								
Order example      702114 / 8 - 4 3 5 6 - 23 / 214 , ...								

<sup>a</sup> List extra codes in sequence, separated by commas.

## 1.5.3 Scope of delivery

1 device in the ordered version
1 quick start guide
1 mounting frame (only for types 702110 and 702111)
2 mounting elements (only for types 702112, 702113, and 702114)

## 1.5.4 Accessories

Description	Part no.
Setup program	00678822
USB cable, A connector to Micro-B connector, length 3 m	00616250
Activation for math and logic module (setup program required)	00689708
Activation for structured text (setup program required)	00689709
Mounting for DIN rail, for type 702110	00688236
Mounting for DIN rail, for type 702111	00688237

## 1.6 Brief description

The controller series comprises five freely configurable, universally usable compact controllers in various DIN formats to control temperature, pressure, and other process variables.

The devices are characterized by a simple, clearly structured operation supported with texts. Process values and parameters are represented by two 18-segment LCD displays. The types 702112, 702113 and 702114 are additionally equipped with a pixel matrix LCD display for displaying text. In addition, all devices have individual display elements for the switch positions of the outputs as well as for manual mode, ramp function, and timer. The devices are operated using a membrane keyboard with four buttons and can be used under harsh environmental influences thanks to the high IP65 protection type.

Depending on the hardware design, the devices can be used as two-state controllers, three-state controllers, three-step controllers, or continuous controllers. The basic type includes autotuning, a ramp function, a program controller, manual mode, limit value monitoring functions, digital control signals, extensive timer functions, and a service counter. A math and logic function is also available as an option. Furthermore, the user has the option to create his/her own application using structured text (ST code).

The devices can be conveniently configured using a PC with the help of the setup program (incl. program editor and ST editor). No separate voltage supply is required when configuring via the USB interface (USB-powered).

## 1.7 Block diagram

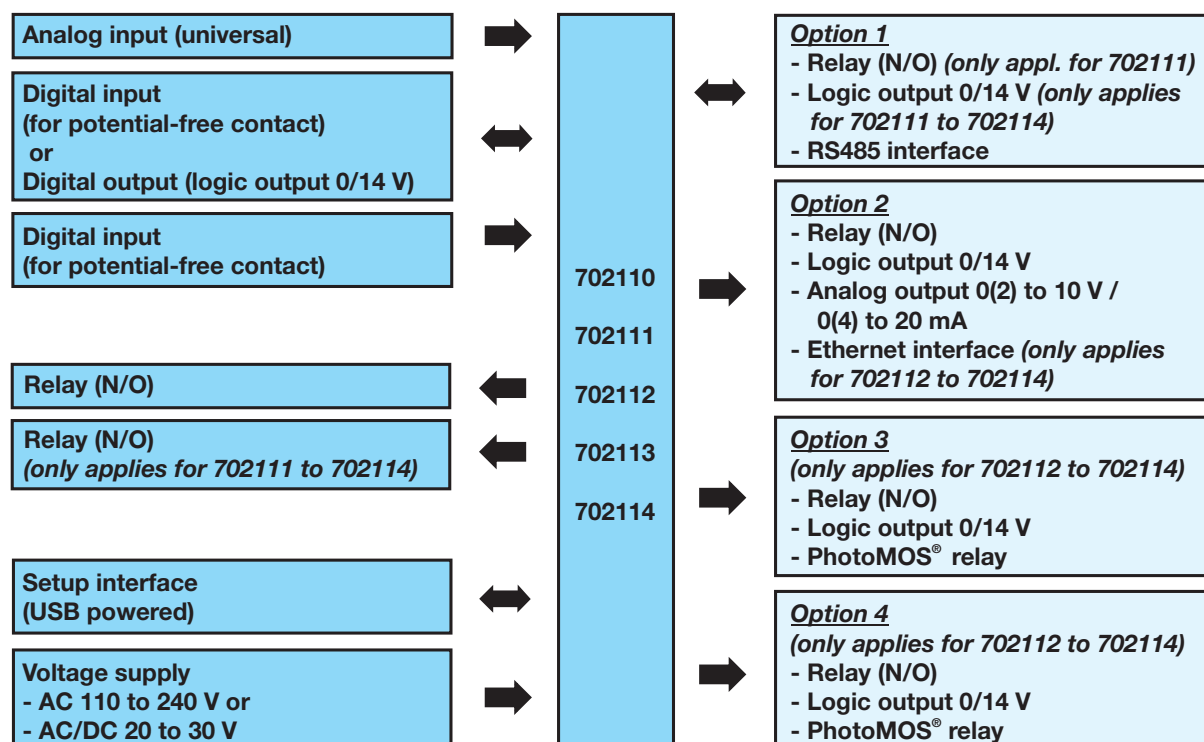

# 1 Introduction

---

## 1.8 Device types



Type 702110 (format 132)



Type 702111 (format 116)



Type 702112 (format 108H)



Type 702113 (format 108Q)



Type 702114 (format 104)

### 2.1 Installation instructions



#### **WARNING!**

**The device is not designed for use in potentially explosive areas.**

Explosion hazard.

- ▶ Only deploy the device outside of potentially explosive areas.

#### **Mounting site**

The device is designed for installation in a panel cut-out within a closed switch cabinet. The front of the device and housing have different protection types (see technical data).

#### **Climatic conditions**

The ambient temperature and the relative humidity at the mounting site must correspond to the technical data. Aggressive gases and vapors have a negative effect on the operating life of the device. The mounting site must be free from dust, powder, and other suspended solids.

#### **Installation position**

The device can be installed in any position.

The maximum admissible ambient temperature only applies for the installation with the display in a vertical position.

#### **Technical data**

⇒ chapter 11 "Technical data", Page 95

### 2.2 Cleaning

The front of the device (front foil) can be cleaned with standard detergents, rinsing and cleaning agents.



#### **CAUTION!**

**The front of the device is not resistant to aggressive acids and lyes, scouring agents, and cleaning with a pressure cleaner.**

Use of these media can cause damage.

- ▶ Only clean the front of the device with suitable agents.

## 2 Mounting

---

### 2.3 Dimensions

Type 702110 (format 132: 48 mm × 24 mm)

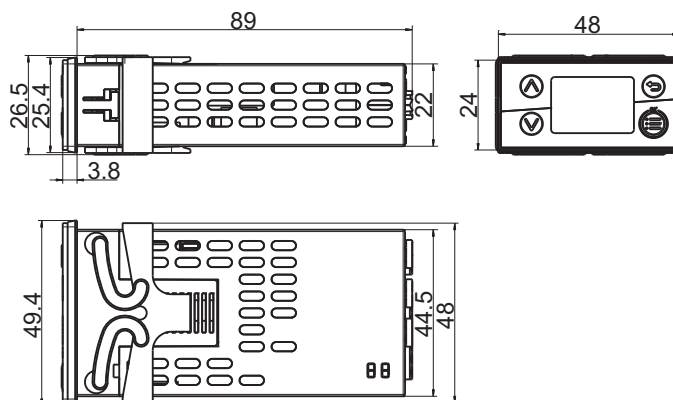

Type 702111 (format 116: 48 mm × 48 mm)

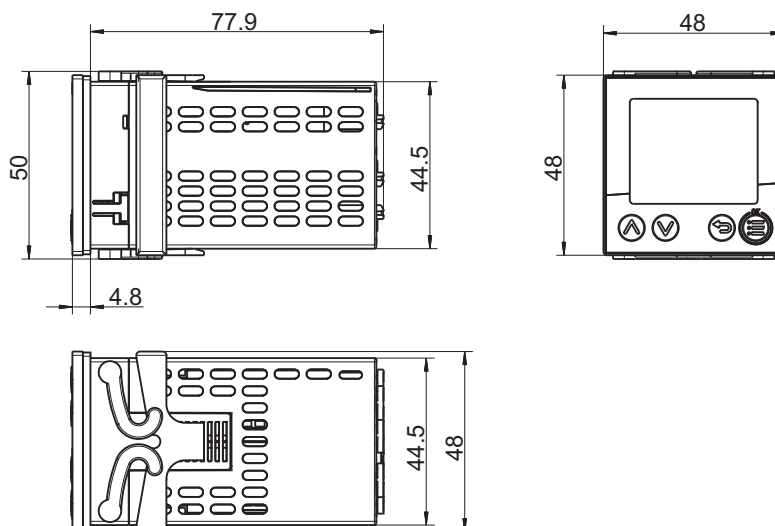



## 2 Mounting

Type 702112 (format 108H: 48 mm × 96 mm)

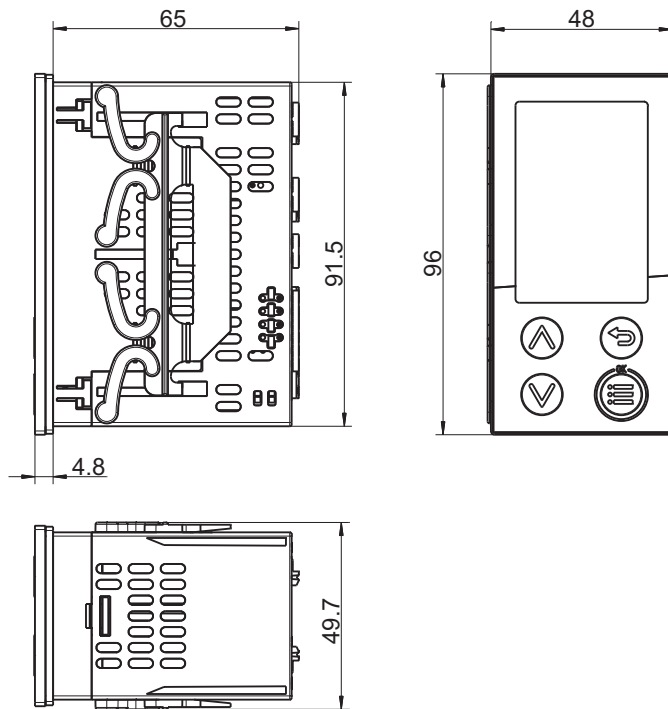

Type 702113 (format 108Q: 96 mm × 48 mm)

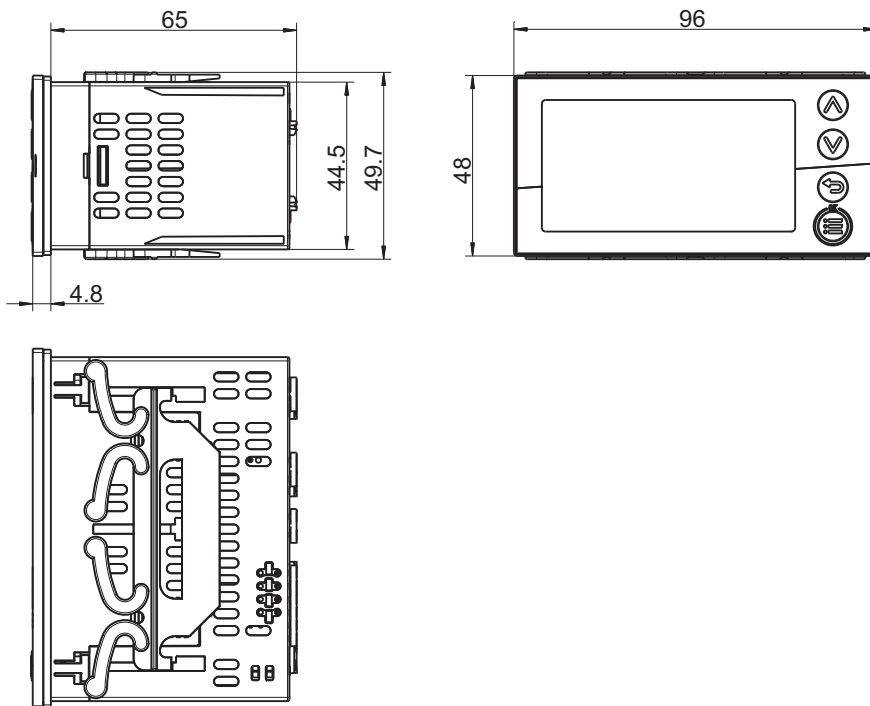

## 2 Mounting

Type 702114 (format 104: 96 mm × 96 mm)

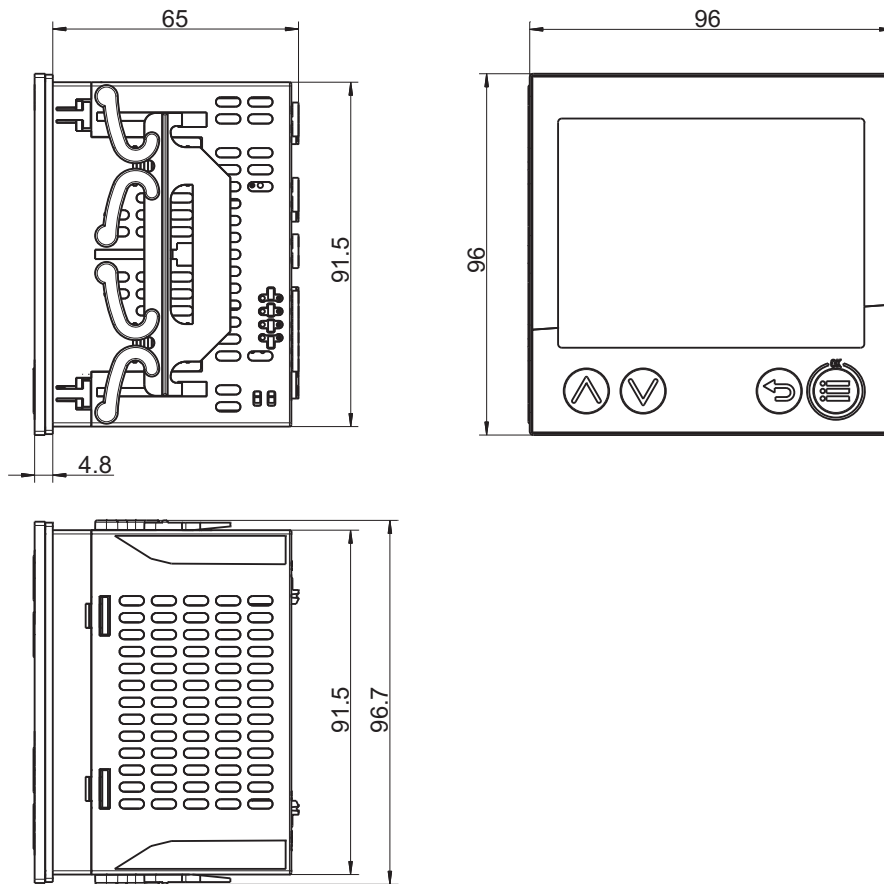

Panel cut-out according to DIN IEC 61554

Type (format; front frame dimensions)	Panel cut-out (width x height)	Minimum spacing of panel cut-outs (for tightly packed installations)	
		Horizontal	Vertical
702110 (132; 48 mm × 24 mm)	45 <sup>+0.6</sup> mm × 22.2 <sup>+0.3</sup> mm	15 mm	30 mm
702111 (116; 48 mm × 48 mm)	45 <sup>+0.6</sup> mm × 45 <sup>+0.6</sup> mm	15 mm	30 mm
702112 (108H; 48 mm × 96 mm)	45 <sup>+0.6</sup> mm × 92 <sup>+0.8</sup> mm	20 mm	30 mm
702113 (108Q; 96 mm × 48 mm)	92 <sup>+0.8</sup> mm × 45 <sup>+0.6</sup> mm	20 mm	30 mm
702114 (104; 96 mm × 96 mm)	92 <sup>+0.8</sup> mm × 92 <sup>+0.8</sup> mm	20 mm	30 mm

Type 702110 (format 132) mounted on DIN rail (see accessories)

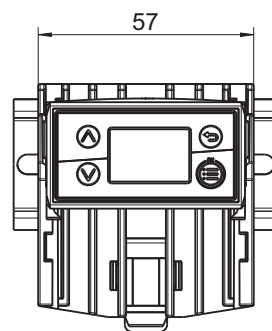
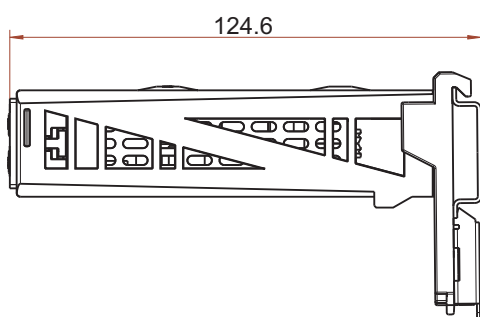

Type 702111 (format 116) mounted on DIN rail (see accessories)

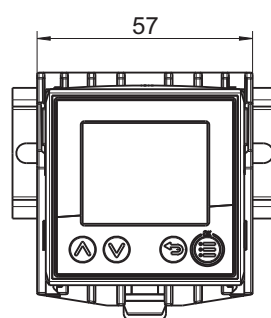
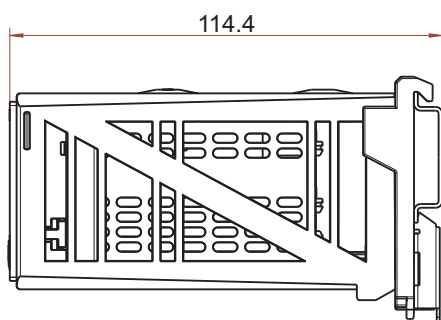

## 2 Mounting

### 2.4 DIN rail installation

For devices in the formats 132 and 116, special mounting elements for mounting on a DIN rail (35 mm, according to DIN EN 60715) are available as accessories. This involves a base plate attached to the DIN rail and a device holder (see depictions in the section "Dimensions").

Process:

- 1) Mount the base plate on the DIN rail from above and press down until it engages.
- 2) Insert the mounting frame (included in the scope of delivery of the device, see Panel mounting) into the device holder from above (front).
- 3) Insert the device (without panel seal) into the device holder from the front and secure using the mounting frame. In doing so, ensure sufficient attachment (see Panel mounting).
- 4) Carry out electrical connection.  
To facilitate the connection, the device holder can be mounted in the base plate from above with its underside positioned vertically (top connection terminals). It is also possible to mount the device holder with its front positioned horizontally so that the connection terminals can be accessed from the front. After connection, the device holder must be removed from this position!
- 5) Insert the device holder into the side recesses of the base plate with its rear detent lugs (format 132: top and center recesses) and press down until it engages.

The following graphic shows the final insertion (A) of the device holder into the base plate as well as the temporary mounting to facilitate the electrical connection, either vertically (B) or horizontally (C).

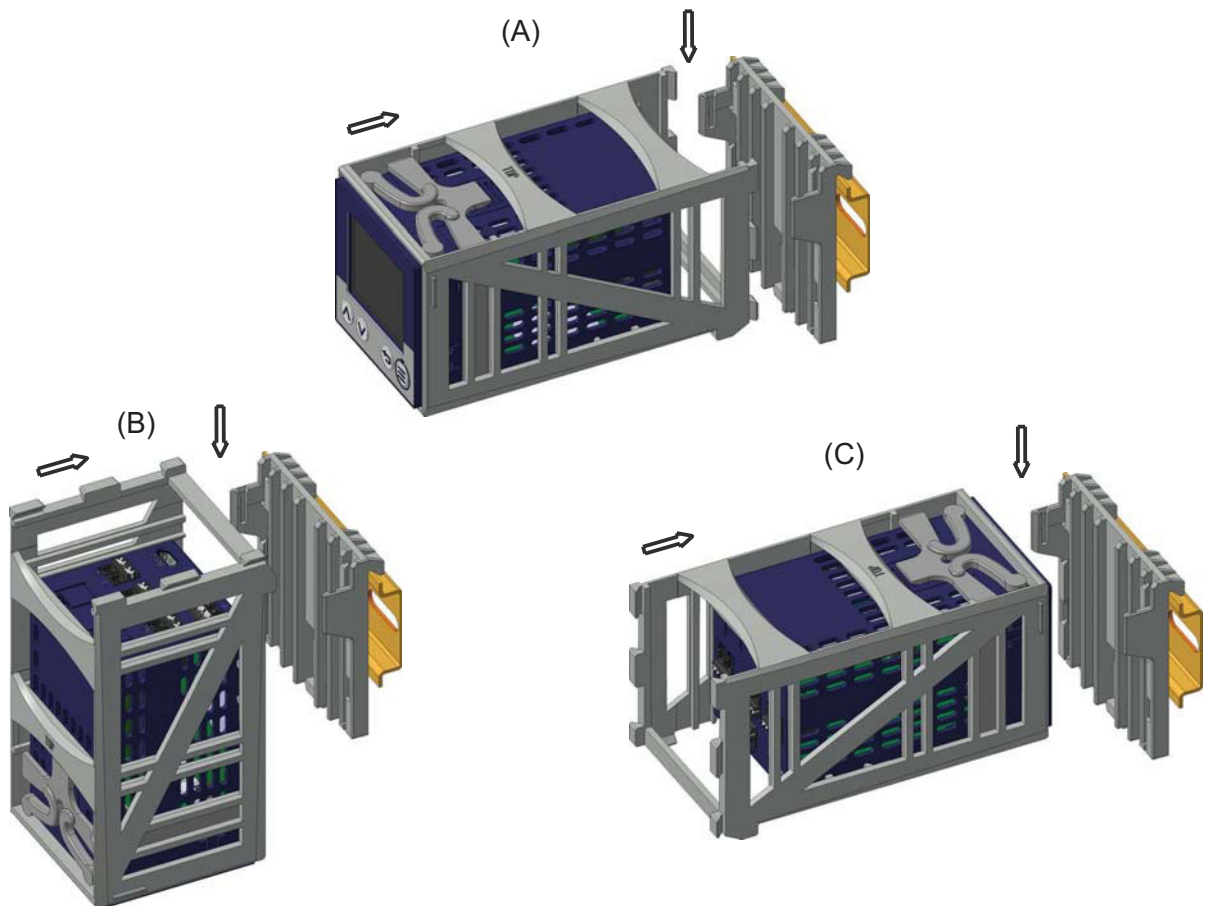

### 2.5 Panel mounting

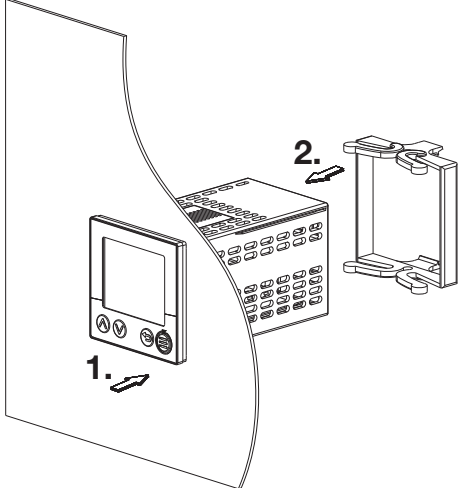
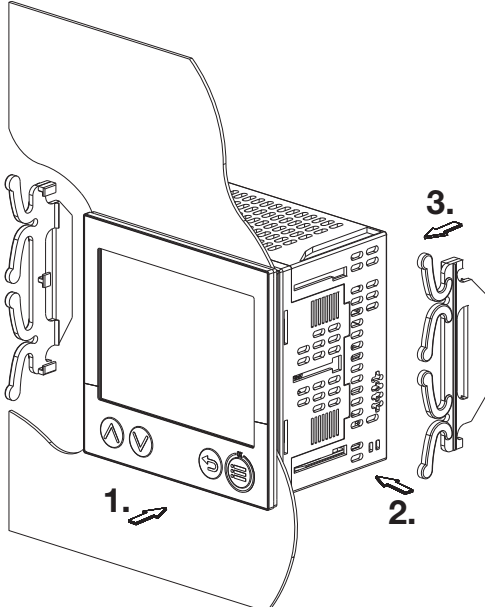
Types 702110 (format 132), 702111 (format 116)	Types 702112 (format 108H), 702113 (format 108Q), 702114 (format 104)
	
<ol style="list-style-type: none"> <li>1. Insert the device from the front into the panel cut-out and ensure that the seal is correctly positioned.</li> <li>2. Push the mounting frame from the panel rear onto the device body and press the springs against the panel rear until the detent lugs engage in their slots and the frame is sufficiently fastened.</li> </ol>	<ol style="list-style-type: none"> <li>1. Insert the device from the front into the panel cut-out and ensure that the seal is correctly positioned.</li> <li>2. From behind the panel, insert both mounting elements at the side into the three recesses of the device case using the guide lugs.</li> <li>3. Press both mounting elements evenly with the springs against the panel rear until the detent lugs engage in their slots and the frame is sufficiently fastened.</li> </ol>



#### CAUTION!

#### The front of the device and housing have different protection types!

The protection type IP65 (front-side) is only guaranteed if the seal is flush and even.

- ▶ Use the mounting frame or both mounting elements as shown in the figure and ensure an even attachment!

## 2 Mounting

---

## 3.1 Installation notes

### Requirements for personnel

- Work on the device must only be carried out to the extent described and, like the electrical connection, only by qualified personnel.
- Before plugging and unplugging connecting cables, it must be ensured that the acting person is electrostatically discharged (by touching grounded metallic parts, for example).

### Cables, shielding, and grounding

- When selecting the electrical wiring material as well as when installing and connecting the device electrically, comply with the requirements of DIN VDE 0100 "Low-voltage electrical installations" and the applicable country-specific regulations (for example, based on IEC 60364).
- It may be necessary to adhere to special notes relating to the heat resistance of cables (see connection diagram).
- Route input, output, and supply lines separately and not parallel to one another.
- Only use shielded and twisted probe and interface cables. Do not route the lines close to current-carrying components or cables.
- For temperature probes, ground the shielding on one side in the control cabinet.
- Do not perform loopthroughs on the grounding cables, but instead route the cables individually to a shared grounding point in the control cabinet; in doing so, ensure that the cables are as short as possible.  
Ensure that the potential equalization is correct.

### Electrical safety

- The device is intended to be installed in control cabinets or plants. Ensure that the customer's fuse protection does not exceed 20 A. Disconnect the device from the mains voltage on all poles prior to starting service or repair work.
- The relay's load circuit can be operated with a hazardous electrical voltage (e.g. 230 V). De-energize the load circuit during mounting/dismounting and electrical connection.
- To prevent the relay contacts being destroyed in the case of an external short-circuit in the load circuit, the latter must be fuse-protected as per the maximum admissible relay current (see technical data).
- The device is not suitable for installation in potentially explosive areas.
- In addition to a faulty installation, incorrectly set values on the device can also impair the correct function of the downstream process. Therefore, ensure that safety devices independent of the device, e.g., overpressure valves or temperature limiters/monitors, are present and that it is only possible for qualified personnel to define settings. Please observe the corresponding safety regulations in this context.

### References to other information

- The electromagnetic compatibility conforms to the standards and regulations cited in the technical data.
- In general, please observe the specifications regarding electrical isolation.

### Setup interface

- The setup interface (USB) is not intended for a permanent connection. Always disconnect the USB cable from the device as soon as you have finished working with the setup program.

# 3 Electrical connection

## 3.2 Connection elements

### Type 702110 (format 132)

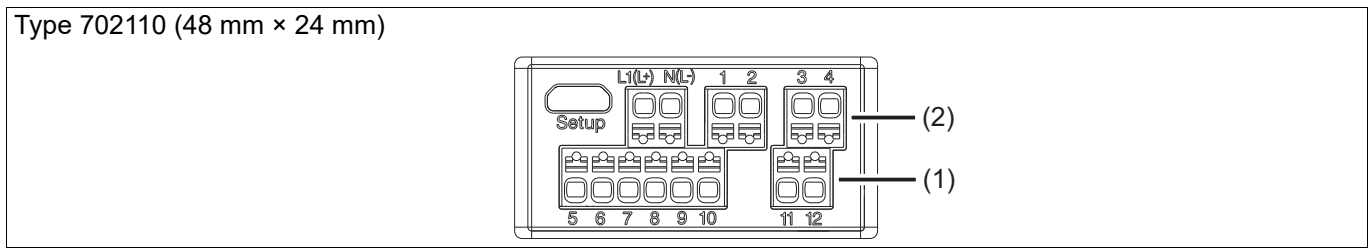

Terminals	Connection	Terminals	Connection	Terminals	Connection
1, 2	Output 1 (relay)	8, 10	Input 2 (for potential-free contact)	L1(L+), N(L-)	Voltage supply
3, 4	(2) = option 2: output 2 (relay, logic or analog output)	9, 10	Input 1 (for potential-free contact) or output 3 (logic output)	Setup (USB)	PC (setup program)
5-8	Analog input	11, 12	(1) = option 1: RS485 interface		

### Type 702111 (format 116)

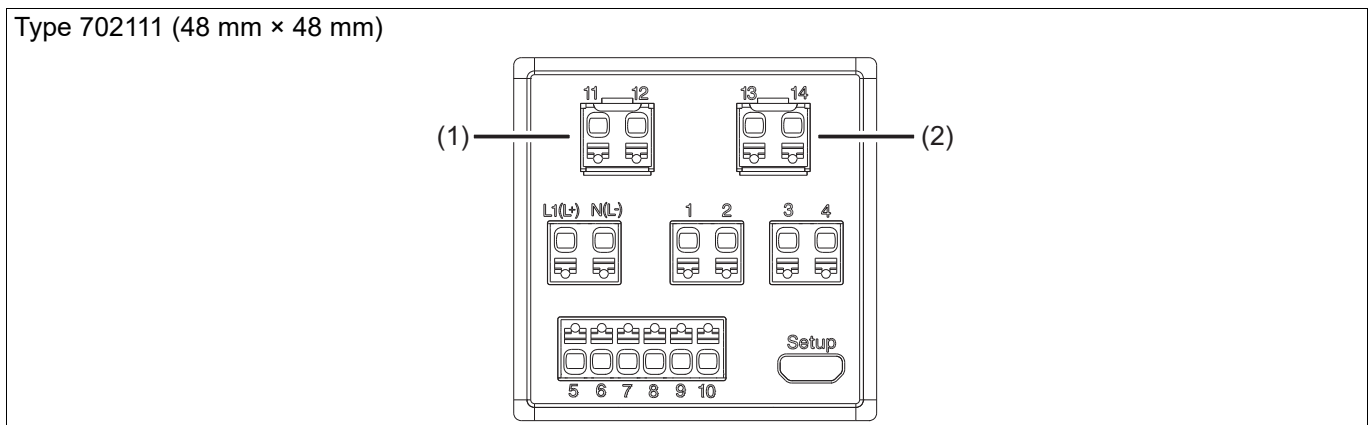

Terminals	Connection	Terminals	Connection	Terminals	Connection
1, 2	Output 1 (relay)	8, 10	Input 2 (for potential-free contact)	13, 14	(2) = option 2: output 5 (relay, logic or analog output)
3, 4	Output 2 (relay)	9, 10	Input 1 (for potential-free contact) or output 3 (logic output)	L1(L+), N(L-)	Voltage supply
5-8	Analog input	11, 12	(1) = option 1: output 4 (relay, logic output) or RS485 interface	Setup (USB)	PC (setup program)

### Types 702112 (format 108H), 702113 (format 108Q), 702114 (format 104)

If the device is equipped with the Ethernet interface (option 2: RJ45 socket), terminals 11 to 14 are not available.



# 3 Electrical connection

Type 702113 (96 mm × 48 mm)

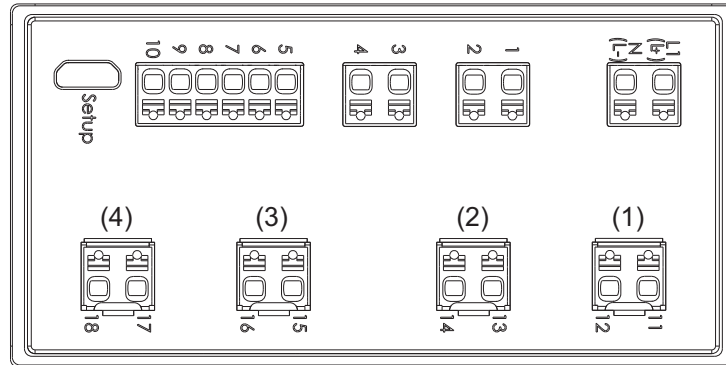

Type 702112 (48 mm × 96 mm)

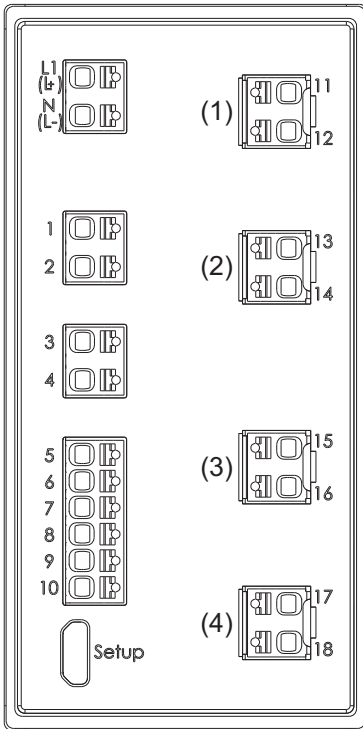

Type 702114 (96 mm × 96 mm)

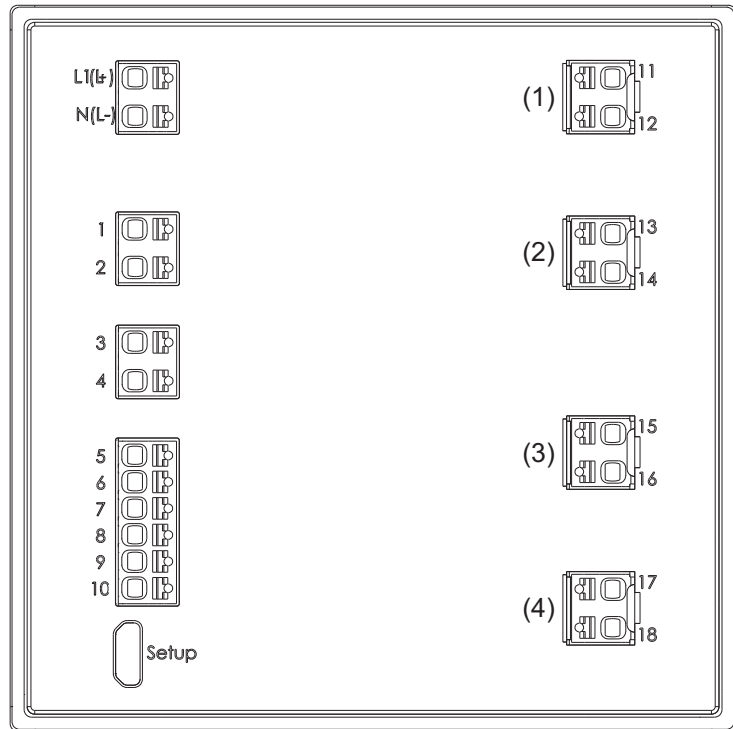

Terminals	Connection
1, 2	Output 1 (relay)
3, 4	Output 2 (relay)
5-8	Analog input
8, 10	Input 2 (for potential-free contact)

Terminals	Connection
9, 10	Input 1 (for potential-free contact) or output 3 (logic output)
11, 12	(1) = option 1: output 4 (logic output) or RS485 interface
13, 14	(2) = option 2: output 5 (relay, logic or analog output)
15, 16	(3) = option 3: output 6 (relay, logic output or PhotoMOS <sup>®</sup> relay)

Terminals	Connection
17, 18	(4) = option 4: output 7 (relay, logic output or PhotoMOS <sup>®</sup> relay)
L1(L+), N(L-)	Voltage supply
Setup (USB)	PC (setup program)

# 3 Electrical connection

## 3.3 Connection diagram



**CAUTION!**

In unfavorable conditions, the temperature may exceed 60 °C at the terminals.

As a result, the insulation of the cables connected at the terminals may be damaged.

- ▶ The affected cables must be heat-resistant up to at least 80 °C.



**NOTE!**

There is an individual connection diagram on the housing that corresponds to the ordered device version.

### 3.3.1 Analog input

The analog input version is identical for all types.

Measuring probe/ standard signal	Symbol and terminal designation	Measuring probe/ standard signal	Symbol and terminal designation
Thermocouple	6 7	Current DC 0(4) ... 20 mA	6 7
RTD temperature probe two-wire circuit	5 7	Resistance/potentiometer two-wire circuit	5 7
RTD temperature probe three-wire circuit	5 6 7	Resistance/potentiometer three-wire circuit	5 6 7
Voltage DC 0(2) ... 10 V (useable as alternative to digital input 2)	8 7	Resistance transmitter	5 6 7

A = Start  
E = End  
S = Slider

### 3.3.2 Digital inputs

The digital input version is identical for all types.

Input	Version	Symbol and terminal designation	Input	Version	Symbol and terminal designation
1	Digital input for potential-free contact (useable as alternative to digital output 3)	9 10	2	Digital input for potential-free contact (only usable if the analog input is not configured as DC 0(2) ... 10 V)	8 10

## 3 Electrical connection

### 3.3.3 Analog output

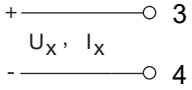
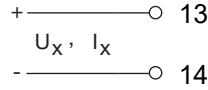
Version for type 702110 (format 132)			Version for types 702111 to 702114		
Output		Symbol and terminal designation	Output		Symbol and terminal designation
2	<b>Option 2</b> (alternative to digital output 2): DC 0/2 ... 10 V or DC 0/4 ... 20 mA (configurable)	 $U_x, I_x$	5	<b>Option 2</b> (alternative to digital output 5): DC 0/2 ... 10 V or DC 0/4 ... 20 mA (configurable)	 $U_x, I_x$

### 3.3.4 Digital outputs

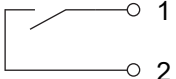
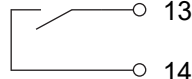
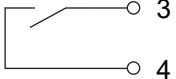
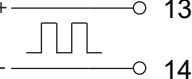
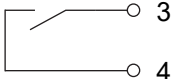
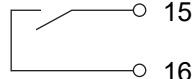
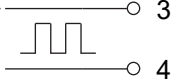
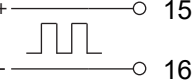
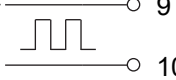
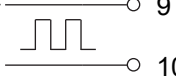
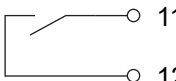
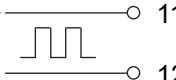
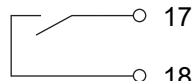
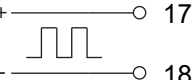
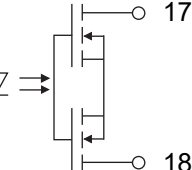
Output	Version	Symbol and terminal designation	Output	Version	Symbol and terminal designation
1	Relay (N/O contact)		5	<b>Option 2</b> for types <b>702111 (116)</b> , <b>702112 (108H)</b> , <b>702113 (108Q)</b> and <b>702114 (104)</b> (alternative to analog output): Relay (N/O contact) or logic output 0/14 V	
2	Relay (N/O contact), (for type 702110 as option 2, see below)				
	<b>Option 2</b> for type <b>702110 (132)</b> (alternative to analog output): Relay (N/O contact) or logic output 0/14 V		6	<b>Option 3</b> for types <b>702112 (108H)</b> , <b>702113 (108Q)</b> and <b>702114 (104)</b> : Relay (N/O contact) or logic output 0/14 V or PhotoMOS <sup>®</sup> relay	
					
3	Logic output 0/14 V (usable as alternative to digital input 1)		7	<b>Option 4</b> for types <b>702112 (108H)</b> , <b>702113 (108Q)</b> , and <b>702114 (104)</b> : Relay (N/O contact; only with longer contact life) or logic output 0/14 V or PhotoMOS <sup>®</sup> relay	
4	<b>Option 1</b> for types <b>702111 (116)</b> , <b>702112 (108H)</b> , <b>702113 (108Q)</b> , and <b>702114 (104)</b> (alternative to RS485 interface): Relay (N/O contact), only for type <b>702111 (116)</b> or logic output 0/14 V	 			  

# 3 Electrical connection

## 3.3.5 RS485 interface

Version for type 702110 (format 132)	Symbol and terminal designation	Version for types 702111 to 702114	Symbol and terminal designation
Option 1: RS485 interface	RxD/TxD+ —○ 11 RxD/TxD- —○ 12	Option 1 (alternative to digital output 4): RS485 interface	RxD/TxD+ —○ 11 RxD/TxD- —○ 12

## 3.3.6 Voltage supply

Version (see nameplate)	Symbol and terminal designation	Version (see nameplate)	Symbol and terminal designation
AC 110 to 240 V	L1 —○ L1/L+ N —○ N/L-	AC/DC 20 to 30 V	L+ —○ L1/L+ L- —○ N/L-



**NOTE!**

No separate voltage supply is required for configuring using the setup program as the device is supplied via the USB interface (USB-powered). For a device in format 108H, 108Q, or 104, in this case the standard digital outputs are activated and the digital outputs of the options are deactivated.

## 3.4 Galvanic isolation

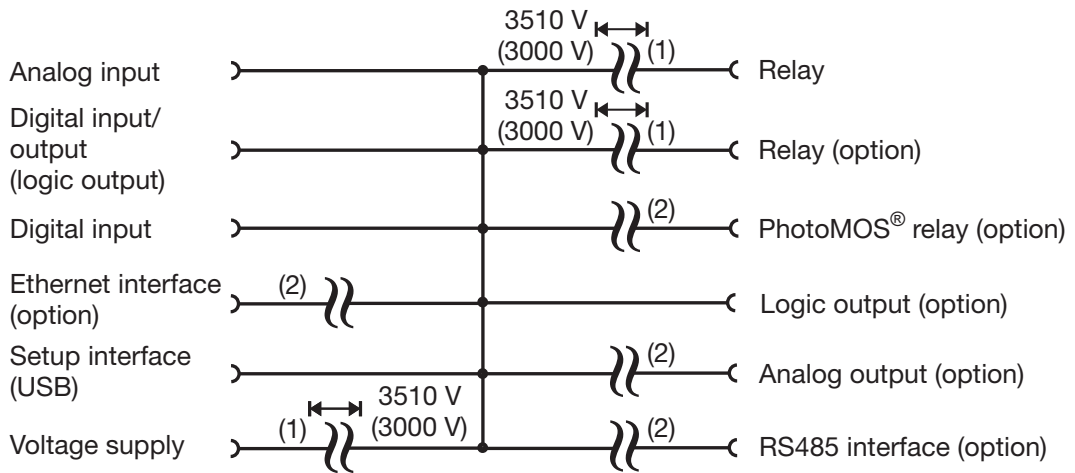

- 1 The voltage specifications correspond to the test voltages (alternating voltage, rms values) according to EN 61010-1:2011-07 for the type test. Type 702110 (format 132): 3000 V instead of 3510 V.
- 2 Functional galvanic isolation for the connection of SELV or PELV circuits.



**CAUTION!**

**The measuring input and the USB interface are not electrically isolated.**

- ▶ Do not connect the USB with a grounded sensor, even if the ground of the PC is grounded (e.g. a desktop PC).

The device is configured, parametrized, and operated using the four buttons on the front. A setup program is also available for convenient configuration of the device using a PC. Some functions can only be configured with the setup program.



The individual parameters for device setting are organized in different levels that can be inhibited. The level inhibit helps to prevent accidental or unauthorized operation.

## 4.1 Display and control elements



- 1 18-segment LCD display (e.g. actual value), 4-digit, white; for types 702110 (132) and 702111 (116) also for displaying menu items, parameters and text
- 2 18-segment LCD display (e.g. setpoint value), 4-digit (702110 (132): 5-digit, 702111 (116): 8-digit), green; for types 702110 (132) and 702111 (116) also for displaying menu items, parameters, values and text); display "OK" when exiting editing mode (with change)
- 3 Activity display for ramp function/program, timer, manual mode
- 4 For types 702112 (108H), 702113 (108Q) and 702114 (104): pixel matrix LCD display for displaying menu items, parameters and values as well as customer-specific text
- 5 Switching of the digital outputs (yellow = active)
- 6 Up (in the menu: increase value, select previous menu item or parameter; in basic status: increase setpoint value)
- 7 Down (in menu: reduce value, select next menu item or parameter; in basic status: reduce setpoint value)
- 8 Back (in menu: back to previous menu level, exit editing mode without change; in basic status: configurable function)
- 9 Menu/OK (call up main menu, switch to submenu/level, switch to editing mode, exit editing mode with change)



### Symbols (activity displays)

Symbol	Off	Lights up	Flashes
	Ramp function or program controller is not active and also not configured	Ramp function or program controller is configured but not active	Ramp function or program controller is active
	Timer is not active and also not configured	Timer is configured but not active	Timer is active (running)

## 4 Operation

Symbol	Off	Lights up	Flashes
Manual mode 	Manual mode is not active (= automatic mode)	Manual mode is active The outputs can be manually controlled using the "Up" and "Down" buttons: Increase/decrease output level (or three-step controller: Open/close actuator).	---

### Button functions

Button or button combination (permanent)	In basic status	Function	
		When navigating	When editing
Up 	Increase setpoint value In manual mode: Increase output level (or open actuator in the case of the three-step controller)	Select previous menu item or parameter	Increase value or go up in picklist
Down 	Decrease setpoint value In manual mode: Decrease output level (or close actuator in the case of the three-step controller)	Select next menu item or parameter	Decrease value or go down in picklist
Back short (< 2 s) 	Function configurable (default setting: without function)	Move to menu level above	Leave editing mode without changes
Back long (> 2 s) 	Function configurable (default setting: switch to manual mode / end manual mode)	---	---
Menu/OK short (< 2 s) 	Call up main menu	Call up sub-menu or switch to editing mode	Leave editing mode with changes
Up + Down long (> 2 s)  + 	Start/stop autotuning	---	---
Down + Menu/OK very long (> 5 s)  + 	Call up menu for level inhibit	---	---

## 4.2 Language selection

After switching on the device for the first time, the user can either confirm the flashing displayed language with "OK" or select another language using the "Up"/"Down" buttons and then confirm this with "OK".

If, at a later point, another user is to also have the option of selecting a language, the configuration parameter "Language selection active" must be set to "Yes" (Configuration > System data). After applying the language, this parameter is automatically set to "No", so that language selection is not necessary the next time the device is switched on.

The language of the device texts can be changed at any time in the configuration settings (regardless of language selection after switch-on).

## 4.3 Basic status

The following displays and functions are supported in the basic status.

### Displays

The values for the analog signals are shown in the displays as a function of the configuration (Configuration > Display/operation).

Default setting:

- Display 1 (top 18-segment display): Analog input
- Display 2 (bottom 18-segment display): Current setpoint value
- Display 3 (top line of the pixel matrix display, only for types 702112 (format 108H), 702113 (108Q), 702114 (104)): No display
- Display 4 (bottom line of the pixel matrix display, only for types 702112, 702113, 702114): No display

### Setpoint value

The setpoint value can be adjusted directly using the "Up" and "Down" buttons.



#### NOTE!

The controller and the program controller are operated by digital signals. These signals (also the function of the "Back" button) must be assigned to the individual functions during configuration:

Configuration > Controller

Configuration > Program controller

Example:

Start the program by short-pressing the "Back" button (return key):

Configuration > Program controller > Control signals > Start signal: Operation > Return key brief (< 2 s)

If the "Long-press back button" function is to be used, its factory configuration must be deactivated:

Configuration > Display/operation > Return key long (> 2 s): Without function

### Timer mode

The "Display change upon timer start" function (Configuration > Display/operation) has the effect that, once the timer is started ("Timer" symbol flashing), the timer's runtime or the remaining time is shown on the bottom display.

If the setpoint value adjustment in the basic status is deactivated (Configuration > Display/operation), the remaining time can be changed with the "Up" and "Down" buttons.

In order to show the timer value (set time), the "Back" button can be configured accordingly (Configuration > Display/operation).

# 4 Operation

---

## Manual mode

With the corresponding configuration (Configuration > Display/operation), the "Back" button can be used to switch to manual mode (default setting: press key for more than 2 seconds).

The "Manual mode" symbol is illuminated during manual mode.

## Autotuning

Autotuning is started by long-pressing (> 2 s) the "Up" and "Down" buttons at the same time.

The text "Autotuning" is displayed whilst autotuning is running.

## Message texts

A configurable message text can be shown on both the top and bottom display. The text display is controlled by a digital signal.

The "ST code" option (extra code) gives the user the option to select up to 10 additional configurable display texts (Configuration > Display/operation > Display texts).

## 4.4 Manual mode

After changing over to manual mode – for all controller types except the three-step controller – either the current output level or a specific, adjustable output level is displayed and output (configurable). The "Up" and "Down" buttons can be used to change the output level.

For the three-step controller, the actuator gradually opens each time the "Up" button is pressed (display "Open"), and gradually closes each time the "Down" button is pressed (display "Close").

It is also possible to switch to manual mode through a digital signal.

Manual mode can be generally inhibited in the configuration. It is also possible to inhibit manual mode through a digital signal.



### NOTE!

The controller automatically changes to manual mode in the event of overrange or underrange (even if manual mode is disabled or locked).

---

## 4.5 Operating levels

### Main menu

The "Menu/OK" button must be pressed to switch from the basic status to the main menu (menu).

As well as the actual operating levels (user level, parameterization, configuration), the main menu contains the "Device information" menu for displaying device information (name, version number), checking the counter readings, and resetting to default settings. If the device has been configured as a program controller, the program editor is also part of the main menu.

### Navigating through the menus

The individual sub-menus in the menu can be selected by pressing the "Up" and "Down" buttons. Pressing the "Menu/OK" button again takes you to the relevant sub-menu or parameter (editing mode). The "Back" button returns you to the next menu level up or takes you out of editing mode without changes.

To change a parameter, the desired value or setting must be selected in editing mode using the "Up" and "Down" buttons. The change is applied using the "Menu/OK" button and editing mode is closed (required if "Auto save = no"; if "Auto save = Yes", editing mode is automatically closed after a certain period and changes are applied).

If no further buttons are pressed, the device automatically switches to the basic status after 180 s (default setting for "Timeout operation" parameter; configurable from 30 to 180 seconds).



## Overview of the operating levels and sub-menus

The following overview shows the operating levels of the device and its sub-menus. The individual functions are configured or parameterized in the sub-menus (not shown here). Information about the functions can be found in the corresponding chapters of this manual.

Beyond this, there are functions that can only be configured with the setup program; these functions are not listed here. Information about these functions can also be found in the corresponding chapters of this manual.

Operating level	Sub-menu 1	Sub-menu 2	
User level			
Program editor (only for program controller)	Section 1		
	...		
	Section 24		
Parameterization	Parameter block 1		
	Parameter block 2		
Configuration	System data		
	Display/operation		
	Analog input		
	Digital inputs		
	Analog output (if available)		
	Digital outputs		
	Controller		Controller configuration
			Controller input
			Autotuning
			Setpoint values
			Ramp function
	Program controller		
	Timer		
	Limit value monitoring functions		Limit value monitoring function 1
			...
		Limit value monitoring function 4	
Serial interface (if available)			
Device information	Versions		
	Service		

## Example for changing a configuration parameter

### *Changing the linearization of the analog input*

1. Press the "Menu/OK" button to move from the basic status to the main menu (menu).
2. Press the "Down" (or "Up") button repeatedly until the "Configuration" menu item appears.
3. Press the "Menu/OK" button to move to the "Configuration" sub-menu.
4. Press the "Down" (or "Up") button repeatedly until the "Analog input" menu item appears.
5. Press the "Menu/OK" button to move from to the analog input's configuration menu.
6. Press the "Down" (or "Up") button repeatedly until the "Linearization" menu item appears.
7. Press the "Menu/OK" button to switch to editing mode.

## 4 Operation

---

The current value "Pt100" flashes (default setting for "RTD temperature probe" signal type).

8. Change the current value using the "Down" (or "Up") button until the new value "Pt1000" flashes.
9. Press the "Menu/OK" button to apply the new value and to exit editing mode (if "Auto save" = No).  
Successful application of the new value is confirmed by "OK" being displayed.
10. Press the "Back" button several times to return to the basic status.

### 4.6 Level inhibit

Access to the individual levels can be inhibited. Press and hold the "Menu/OK" and "Down" buttons at the same time for longer than 5 seconds to set the level inhibit.

The corresponding degree of inhibition can be selected using the "Up" and "Down" buttons and confirmed using the "Menu/OK" button.

Inhibited levels
None (all levels free; default setting)
Configuration
Configuration and parameterization
Configuration, parameterization, and program editor
Complete (configuration, parameterization, program editor, and user level)

If the configuration is inhibited, resetting to default settings (Device Info > Service > Factory setting) is also not possible.

### 4.7 User level

The user level is only available on the device. Four setpoint values can be set here. The output level and the analog input's measured value are also displayed here (default setting).

The input limits of the setpoint values are dependent on the configuration of the respective setpoint value (Configuration > Controller > Setpoint values). The input range of -1999 to 9999 shown in the following table represents the maximum possible limits.

No.	Parameter	Selection/text/value	Description
1	Setpoint value 1	-1999 to 9999 (0)	Setpoint value 1
2	Setpoint value 2	-1999 to 9999 (0)	Setpoint value 2
3	Setpoint value 3	-1999 to 9999 (0)	Setpoint value 3
4	Setpoint value 4	-1999 to 9999 (0)	Setpoint value 4
5	Output level display	(Display only)	Current controller output level
6	Measured value	(Display only)	Current measured value of analog input

The selection of the maximum 16 parameters that appear in the user level can be changed or supplemented using the setup program (Setup only > User level).

The setpoint values can also be entered in the setup program in the scope of the controller configuration.

### 4.8 Device information

The device name, various version designations, and counter readings are displayed in this menu. It also includes a function for resetting the device to the default settings.

## 4.8.1 Versions

### Device name

The device name can be changed using the setup program (Configuration level > System data; default setting: Name).

### Software version

Device software version (e.g. 3830102)

The software version number is composed of the basic version (383), the device version (in the example: 01), and the current version (in the example: 02).

### VDN Version

Version of a special device version

### ST code version

Version of the "ST code" extra code

### Hardware version

Device hardware version

## 4.8.2 Service

The counters are configured using the setup program (Setup only > Service):

### Service counter

Service counter reading

### Operating time

Operating hours counter reading

### Factory setting

The device can be reset to the default settings in this menu item. To do so, press the "Menu/OK" button for at least 5 seconds.

The device is automatically restarted once the default settings are applied.

This menu item disappears when the configuration is inhibited (level inhibit).

## 4.9 Error messages

Display	Possible cause <sup>a</sup>	Measures
<<<<	Measuring range underflow Short-circuit (probe/line) Break (probe/line) Polarity	Check sensor and line (break, short-circuit, polarity) Check connection terminals Check configuration (signal type, linearization, resistance measuring range, scaling)
>>>>	Measuring range overflow	
----	Break (probe/line) Polarity	

<sup>a</sup> Depends on the signal type (measuring probe); see chapter "Technical data".

In the event of an error, the controller switches to manual mode.

## 4 Operation

---

This menu is available on the device if the device has been configured as a program controller.  
The default settings are shown in bold in the tables.

## 5.1 Program administration

Using the program editor, the user can create a program for a setpoint value and four operating contacts with up to 24 program sections. The individual program sections and the respective setpoint value can be programmed either on the device or in the setup program. The operating contacts can only be configured using the setup program.

Settings that affect the program sequence (e.g. program start, setpoint value change as a step or ramp, program repeat) are configured in the program controller configuration (accessible in the program editor via the "Generator configuration" button).

Parameter	Selection/text/value	Description
Program name (setup only)	<Enter text> <b>Program 01</b>	Free choice of name for the program
Generator configuration (setup only)	Press button	Use this button to open a menu for configuring the program controller.
Cut (setup only)	Press button	Use this button to cut lines (program sections) that have been marked.
Copy (setup only)	Press button	Use this button to copy lines that have been marked.
Insert (setup only)	Press button	Use this button to insert lines that have been cut or copied above a selected line.
New (setup only)	Press button	Use this button to insert a new line above a marked line.
Remove (setup only)	Press button	Use this button to delete lines that have been marked.
No. (number) (setup only)	Select section to be programmed (starting with section 1)	Number of program section (for program creation with the setup program)
Section 1 to section 24 (device only)	Select section to be programmed (starting with section 1)	Number of program section (for program creation on the device)
Setpoint value 1	-1999 to 9999 <b>(0 to 400)</b>	Setpoint value in corresponding program section The input limits depend on the controller configuration (setpoint value 1: min. limit, max. limit).
Duration	<b>00:00</b> to 59:59 <b>00:00</b> to 23:59 <b>00:00</b> to 99:23	Duration of program section Setting range and unit depend on the program controller configuration ("Time display" parameter): mm:ss hh:mm dd:hh

# 5 Program editor

Parameter	Selection/text/value	Description
Operating contacts (setup only)	Activation of operating contacts (contact 1 to contact 4) by selection (drop-down list)	
	Selected (checkmark)	Operating contact is active Active operating contacts are displayed in the "Operating contacts" field.
	Not selected	Operating contact is not active
OK (setup only)	Press button	Before the entered values are applied, it is checked whether the setpoint values lie within the limits set in the configuration of the controller.
OK with test (setup only)	Press button	The whole test plan is checked to ensure compliance with the limits set in the configuration of the controller.

## Program progression as step or ramp

The following diagrams show the progression of a setpoint value within a program section as a function of the "Program progression step" parameter (program controller configuration).

Yes (step):

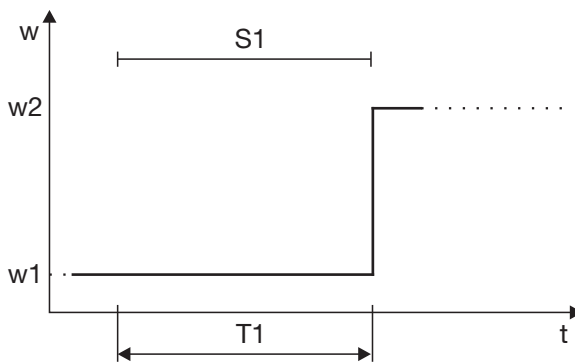

$S_1$  = Program section 1

$T_1$  = Section time 1

No (ramp):

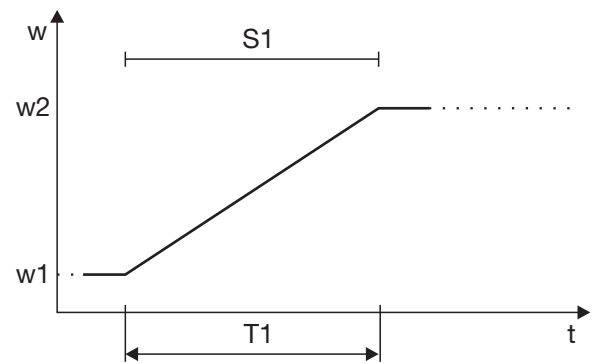

$w_1$  = Setpoint value in program section 1

$w_2$  = Setpoint value in program section 2

The programmed setpoint value determines the setpoint value at the start of the relevant program section.

If "Yes" (step) is specified for the setpoint input, the setpoint value remains constant in the program section. It does not change until the next section that has been programmed with a different setpoint value starts.

If "No" (ramp) is specified for the setpoint input and the next section has been programmed with a different setpoint value, the setpoint value follows a ramp course within the program section. The ramp slope is determined by the section time and the difference between the two setpoint values.

## 5.2 Program simulation (setup only)

The program simulation produces a diagram that shows the progression of the setpoint value and the state of the operating contacts.

The following examples 1 and 2 must show the different setpoint value progression as a function of the "Program progression step" parameter (setpoint step or setpoint ramp). This simple program is used for this purpose:

No.	1.Setpoint [°C]	Duration [mm:ss]	Control contacts
1	20.0	10:00	1
2	100.0	30:00	2
3	100.0	10:00	3
4	80.0	20:00	2
5	80.0	20:00	3
6	20.0	00:01	

### Example 1: Setpoint step

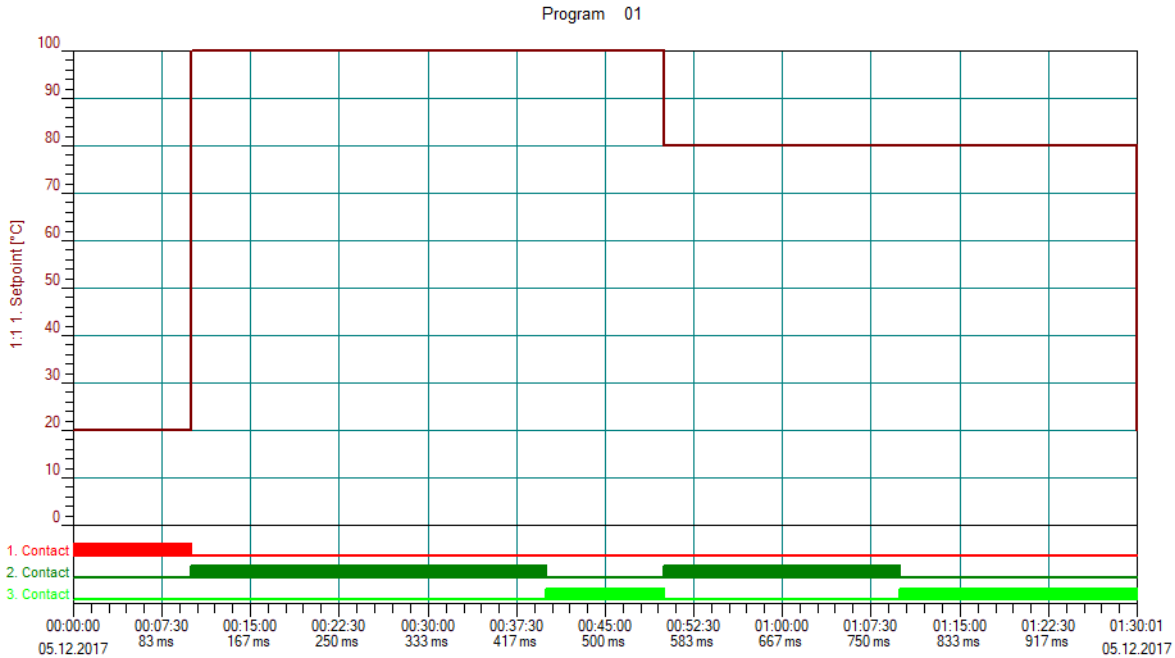

The setpoint value programmed in a section (e.g. 20 in section 1) remains constant for the entire duration of this section. At the start of the next section, the setpoint value jumps to the value for this section (e.g. 100 in section 2).

# 5 Program editor

## Example 2: Setpoint ramp

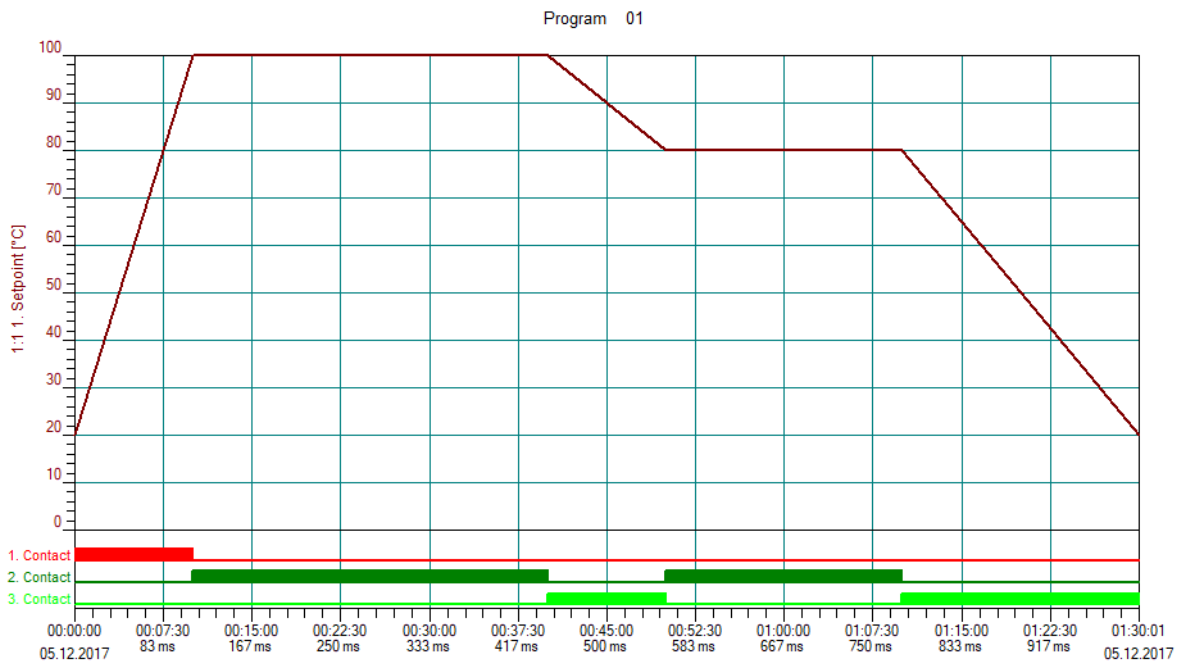

The setpoint value programmed in a section (e.g. 20 in section 1) changes gradually during that section to the setpoint value of the next section (e.g. 100 in section 2). This produces a course in a ramp shape. For a setpoint value to remain constant in a section (e.g. 100 in section 2), the same setpoint value must be specified for the next section (e.g. 100 in section 3).



The designation "Parameter level" is used in the setup program.

The default settings are shown in bold in the tables.

## 6.1 Parameter blocks

The following table shows the parameters in a parameter block. The same parameters are also available for the second parameter block.

Depending on the controller type configured, certain parameters may be omitted or ineffective.

Parameter	Selection/text/value	Description
Control structure 1		These settings determine the control structure (transmission behavior) and relate to the first controller output.
	P	P controller
	I	I controller
	PI	PI controller
	PD	PD controller
	<b>PID</b>	<b>PID controller</b>
Control structure 2	(see: Control structure 1)	These settings apply to the second controller output for a three-state controller.
Xp1 proportional band	<b>0</b> to 9999	Value for the proportional band
Xp2 proportional band	<b>0</b> to 9999	The controller structure has no effect if $X_p = 0$ (behavior identical to limit value monitoring)! For a continuous controller, $X_p$ must be $> 0$ .
Tv1 derivative time	0 to 9999 ( <b>80</b> )	The derivative time (in seconds) influences the differential component (D component) of the controller output signal.  The effect of the D-term increases as the derivation time increases.
Tv2 derivative time	0 to 9999 ( <b>80</b> )	
Tn1 reset time	0 to 9999 ( <b>350</b> )	The reset time (in seconds) influences the integral component (I component) of the controller output signal.  The greater the reset time, the less effect the I component has.
Tn2 reset time	0 to 9999 ( <b>350</b> )	
Cy1 cycle time	0 to 9999 ( <b>20</b> )	The cycle time (in seconds) should be chosen so that the energy supply to the process is as continuous as possible without overloading the switching elements.
Cy2 cycle time	0 to 9999 ( <b>20</b> )	
Xsh contact spacing	<b>0</b> to 999	Spacing between the two control contacts of a three-state controller and three-step controller
Xd1 switching differential	0 to 999 ( <b>1</b> )	Hysteresis for a switching controller with proportional band $X_p = 0$
Xd2 switching differential	0 to 999 ( <b>1</b> )	
TT actuator time	5 to 3000 ( <b>60</b> )	Control valve running time range (in seconds) used for a three-step controller
Y0 working point	-100 to +100 ( <b>0</b> )	Working point correction (in percent) for a P or PD controller (correction value for the output level)  If the actual value has reached the setpoint value, the output level corresponds to the working point Y0.

## 6 Parameterization

---

Parameter	Selection/text/value	Description
Y1 max. output level limit	0 to <b>100</b>	Admissible maximum output level (in percent; only effective if $X_p > 0$ )
Y2 min. output level limit	<b>-100</b> to +100	Admissible minimum output level (in percent; only effective if $X_p > 0$ ) Three-state controller: In order for the second controller output to be active, a negative value must be set.
Tk1 min. relay-on time	<b>0</b> to 9999	Minimum ON period (in seconds) to limit the switching frequency for switched outputs (digital outputs) Recommended setting when using a relay as controller output: $\geq 0.15$ s
Tk2 min. relay-on time	<b>0</b> to 9999	

## 6.2 Controller types

### Two-state controller

This controller has a switched output and can be parameterized with P, PI, PD, or PID transmission behavior. The proportional band  $X_p$  must be greater than 0 for the controller structure to take effect.

If  $X_p = 0$ , the behavior corresponds to the function of limit value monitoring with switching differential  $X_{d1}$  (working point  $Y_0 = 0\%$ ):

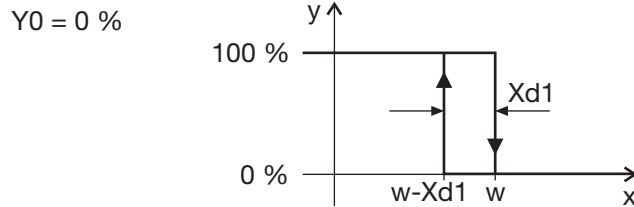

Influence of working point  $Y_0$  on the switching behavior:

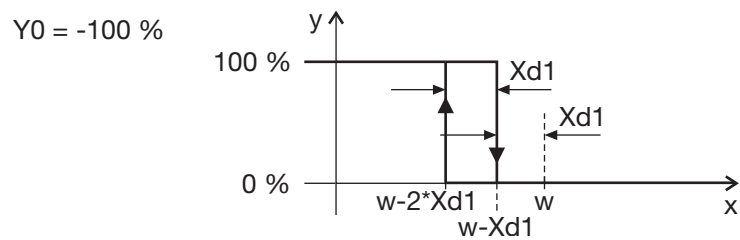
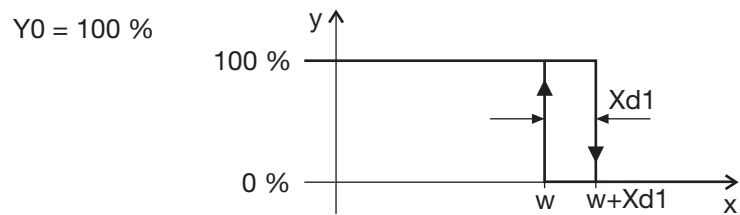
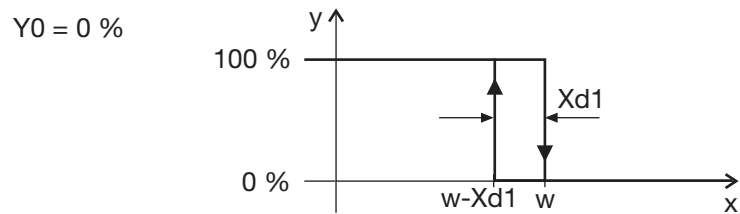

# 6 Parameterization

---

## Three-state controller

This controller has two outputs, which can be configured as continuous (analog output) or switched (digital output). In both cases, the controller can be parameterized with P, PI, PD, or PID transmission behavior. The proportional bands  $X_{p1}$  and  $X_{p2}$  must be greater than 0 for the controller structure to take effect.

If  $X_{p1} = 0$  and  $X_{p2} = 0$ , the behavior corresponds to the function of limit value monitoring with switching differential  $X_{d1}$  and  $X_{d2}$ , and contact spacing  $X_{sh}$  (working point  $Y_0 = 0\%$ ):

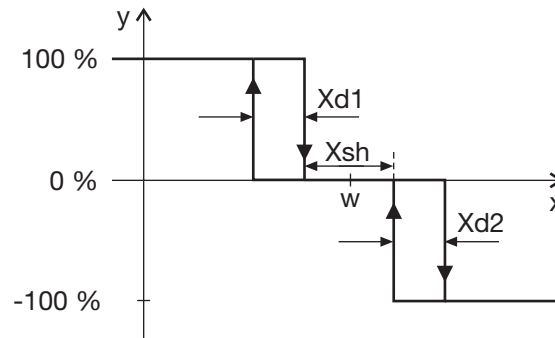

## Three-step controller

This controller has two switched outputs and can be parameterized with PI or PID transmission behavior. The proportional band  $X_p$  must be greater than 0 for the controller structure to take effect.

The three-step controller is used for actuator drives with three switching statuses (actuator open, closed, hold).

## Continuous controller

This controller has a continuous output (analog output) and can be parameterized with P, PI, PD, or PID transmission behavior. The proportional band  $X_p$  must be greater than 0 for the controller structure to take effect (the setting  $X_p = 0$  is not normally used in practice).

This chapter describes the configuration based on the menu items and parameters of the device: **MENU > CONFIGURATION**

The description also applies for the configuration with the setup program (identification, configuration level).

Functions and parameters that only exist on the device or in the setup program are marked as "(device only)" or "(setup only)".

Beyond this, there are additional functions that can only be configured or executed with the setup program. These functions are described in separate chapters:

- ⇒ chapter 8 "Configuration - setup only", Page 77
- ⇒ chapter 9 "Online parameter (setup only)", Page 85
- ⇒ chapter 10 "Start-up parameter (setup only)", Page 91

The default settings are shown in bold in the tables.



## NOTE!

No separate voltage supply is required for configuring using the setup program as the device is supplied via the USB interface (USB-powered). For a device in format 104, in this case the outputs are deactivated.

---

## 7.1 Identification (setup only)

### Device version

The device version is specified in this menu:

- Device type
- Optional inputs and outputs as well as interfaces
- Math/logic extra codes and ST code

The following options are available for this purpose:

- User setting: The device version is selected by the user in the setup program.
- Automatic detection: The device version is read out from the connected device and transferred to the setup program.
- Automatic detection with read out of setup file: The configuration is additionally read out from the device here and transferred to the setup program.

### Connection diagram

The user can use this function to create a connection diagram that shows the current terminal assignment of the device.

There are some text entry fields that can be used for the description at the bottom edge of the connection diagram. Alternatively, the texts from the file info header of the setup file can also be used here (setting in the context menu, see below). There is also one field for the date (editable) and one for the signature.

There is a print function, incl. print preview and printer selection, available via the context menu (mouse pointer in the connection diagram, right mouse button). The features for the protocol to be printed are also defined here (page margins, line type, use of texts from the file info header).

## 7.2 Selectors

The selectors contain signals that are available for configuration on the device or in the setup program. These are device signals (e.g., analog and digital inputs or internal signals), and signals that are transferred to the device via Modbus (external analog and digital inputs, analog and digital flags).

# 7 Configuration

## Analog selector

Category	Signal	Description
No selection		No signal selected
Analog input	Analog input	Analog input signal
Controller	Actual value	Actual value on the controller input
	Setpoint value	Active setpoint value on the controller input
	Sampling rate	Sampling rate (fixed value: 150 ms) Regardless of the sampling rate, the digital outputs are updated at intervals of 10 ms.
	Controller output 1 (analog)	Switched controller output 1 (0 to +100 %; e.g., for heating)
	Controller output 2 (analog)	Switched controller output 2 (-100 to 0 %; e.g., for cooling)
	Controller differential	Difference between setpoint value and actual value of the controller
	Output level display	Controller output level (-100 % to +100 %)
Setpoint values	Setpoint 1 to setpoint 4	Setpoint values that can be selected through the setpoint changeover.
	Current setpoint value	Setpoint value selected through the setpoint changeover
Program setpoints	Program setpoint value	Current program setpoint
Program	Section end value	Setpoint value at the end of the program section
	Section remaining running time	Remaining running time of the current program section in seconds (remaining time)
	Program remaining running time	Remaining running time of the program in seconds (remaining time)
	Section runtime	Runtime of the current program section in seconds (already elapsed time)
	Program runtime	Runtime of the program in seconds (already elapsed time)
Ramp	Ramp end value	End value of the setpoint ramp (corresponds to the specified setpoint value)
	Current ramp setpoint value	Current value of the setpoint ramp
Timer	Timer runtime	Runtime of the timer in seconds (already elapsed time)
	Timer remaining running time	Remaining running time of the timer in seconds (remaining time)
	Timer value	Set timer time in seconds
Ext. analog inputs	Ext. analog input 1 ext. analog input 2	Signal of the external analog inputs 1 and 2 (via interface)
Flags	Analog flag 1 analog flag 2	Analog flags are analog values that can be described and read out as well as internally processed via the interface.
Math result	Math result 1 to math result 4	Results of the math formulae (formula 1 to formula 4)
ST analog outputs	ST analog output 1 to ST analog output 6	Signals of the analog outputs from the PLC module (application created with ST code)

## 7 Configuration

Category	Signal	Description
Service	Terminal temperature	Temperature on the connection terminals
	Service counter	Service counter reading (number or time, configuration dependent)
	Operating time	Operating hours counter reading (in hours or days, configuration dependent)

### Digital selector

Category	Signal	Description
No selection		No signal selected
Digital inputs	Digital input 1 digital input 2	Signals of digital inputs 1 and 2
Controller	Controller off	The signal corresponds to the controller-off signal (switch off controller).
	Autotuning	The signal is active during autotuning.
	Manual mode active	The signal is active during manual mode.
	Controller cycle alarm	Control loop monitoring alarm signal
	Output level alarm	Output level monitoring alarm signal
	Controller output 1 (digital)	Signal on controller output 1 (e.g., for heating with inverse control direction)
	Controller output 2 (digital)	Signal on controller output 2 (e.g., for cooling with inverse control direction)
Program	Program active	The signal is active while the program is running (also while the program is stopped).
	Program tolerance band signal	The signal is active while the actual value is outside the tolerance band.
Operating contacts	Operating contact 1 to operating contact 4	Operating contacts of the program generator
Ramp	End signal ramp	The signal is active after ramp end until the next setpoint value change.
	Ramp tolerance band signal	The signal is active while the actual value is outside the tolerance band.
Limit value monitoring functions	Limit value monitoring function 1 to limit value monitoring function 4	Alarm signals of limit value monitoring functions 1 to 4
Timer	Timer output	The signal is active from timer start until the timer elapses (high active or low active configurable).
	Timer tolerance band signal	The signal is active if the actual value before the timer start is outside the tolerance band.
	Timer end signal	The signal is active after the timer elapses for the duration of the after-run time (or until acknowledgement).
	Timer stop signal	The signal is active while the timer is stopped.
Digital control signals	Digital control signal 1 to digital control signal 4	Output signals of the respective function (configurable)
Ext. digital inputs	Ext. digital input 1 ext. digital input 2	Signal of the external digital inputs 1 and 2 (via interface)

## 7 Configuration

Category	Signal	Description
Flags	Digital flags 1 digital flags 2	Digital flags are binary values that can be described and read out as well as internally processed via the interface.
Logic	Logic result 1 to logic result 4	Results of the logic formulae (formula 1 to formula 4)
ST digital outputs	ST digital output 1 to ST digital output 4	Signals of the digital outputs from the PLC module (application created with ST code)
ST alarm/error	ST alarm	Alarm signal from the PLC module (application created with ST code)
	ST error	Error signal from the PLC module (application created with ST code)
Service	Service signal	The signal is activated if the service counter has reached the set limit value and remains active until acknowledgement.
Operation	Short-press back button (< 2 s)	The signal is active (for the duration of a sampling period) after briefly pressing the "Back" button.
	Long-press back button (> 2 s)	The signal is active (for the duration of a sampling period) after long-pressing the "Back" button.

### 7.3 System data

The general system data is configured in this menu.

Parameter	Selection/text/value	Description
Device name (setup only)	<b>Name</b> (editable)	Device designation (in the "Device information" menu)
National language	German English French Spanish	National language of display texts
Language selection active	No <b>Yes</b>	Language selection after switching on the next time  If "Yes", the user can select the national language for the device texts after the next time the device is switched on - following the change to the configuration.  After applying the national language, this parameter is automatically set to "No", so that language selection is not necessary the next time the device is switched on.
Temperature unit	°C °F	Temperature unit for the display on the device and in the setup program (automatic conversion from °C to °F)
Temp. unit interface	°C °F	Temperature unit for temperature values transferred via the serial interface.

### 7.4 Display/operation

Settings are implemented in this menu that affect the function of the displays and the device buttons.



## 7 Configuration

Parameter	Selection/text/value	Description
Display 1	Analog selector <b>Analog input</b>	Analog signal that is shown in the first 18-segment display (top, white).
Display 2	Analog selector <b>Current setpoint value</b>	Analog signal that is shown in the second 18-segment display (bottom, green).
Display 3	Analog selector <b>No selection</b>	Analog signal that is shown in the top line of the pixel matrix display (only for formats 108H, 108Q, and 104).
Display 4	Analog selector <b>No selection</b>	Analog signal that is shown in the bottom line of the pixel matrix display (only for formats 108H, 108Q, and 104).
Timer start display change		Display change when starting the timer:
	Without function	No display change
	<b>Timer remaining running time</b>	Display of the remaining running time
	Timer runtime	Display of the runtime
Auto save (setup only)	Yes	Editing mode is automatically exited after a certain period and a change is applied.
	<b>No</b>	The "Menu/OK" button must be pressed to exit editing mode with the application of a change.
Setpoint value adjustment (setup only)	<b>Yes</b>	The current setpoint value can be entered directly in the basic status using the "Up" and "Down" buttons.
	No	Setpoint value adjustment is not allowed in the basic status.
Level inhibit (setup only) The level inhibit can be adjusted on the device using a key combination. 		Access to the individual levels can be inhibited:
	<b>None</b>	No level inhibited
	Conf	Configuration level inhibited
	Conf + para	Configuration level and parameter level inhibited
	Conf + para + prog	Configuration level, parameter level, and program editor level inhibited
	Complete	Configuration level, parameter level, program editor level, and user level inhibited
Time-out operation	30 to <b>180</b> 0 = Switched off	Time period (in seconds), after which the device automatically returns to the basic status if no key is pressed.
Contrast	1 to 10 ( <b>8</b> )	Contrast of the displays
Running speed	1 to 3 ( <b>2</b> )	Running speed of the display text
Short-press back button (< 2 s)	<b>Without function</b> Manual mode Start autotuning Display timer value	Function of the "Back" button when short-pressing the button (less than two seconds) Additional functions of the button can be selected in the configuration of the individual device functions (digital selector).
Long-press back button (> 2 s)	<b>Manual mode</b> (See above for other functions)	Function of the "Back" button when long-pressing the button (more than two seconds)
Start delay time	<b>0</b> to 300 s	Start delay time (in seconds) after Power ON All functions of the device are only active after this time has elapsed.

# 7 Configuration

Parameter	Selection/text/value	Description
Key lock	Digital selector <b>No selection</b>	Digital signal (high active) for inhibiting the buttons
Display off	Digital selector <b>No selection</b>	Digital signal (high active) for switching off all displays
Additional functions (setup only)	Expansion 1 to Expansion 5	Reserved functions for service purposes. Only activate when instructed to do so by service personnel!  Click checkbox to activate the function.

## Level inhibit

⇒ chapter 4.6 "Level inhibit", Page 34

## Display texts (setup only)

Up to 10 display texts can be entered in the setup program (Configuration level > Display/operation > Display texts). These can be selected through the corresponding programming using an ST code so that they are displayed on the device.

Parameter	Selection/text/value	Description
Display text 1 to Display text 10	<Enter text> <b>ST text 0</b> to <b>ST text 9</b>	The text to be output must be selected in the ST code via text index 1 to 10 (0 = do not output text). The line where the text is to be displayed must also be specified here.

In addition, there are two other texts available that are displayed on the device - regardless of the ST code. The display is controlled by a digital signal. This way, an alarm text can, for example, be displayed in a simple way if a limit value is exceeded. To do so, the signal of the limit value monitoring function must be used to control the text display.

Parameter	Selection/text/value	Description
Message text 1	<Enter text> <b>Message text 0</b>	Formats 108H, 108Q, and 104: The text is displayed in line 3.  Formats 132 and 116: Without function
Message text 2	<Enter text> <b>Message text 1</b>	Formats 108H, 108Q, and 104: The text is displayed in line 4.  Formats 132 and 116: The text is displayed in line 2.
Top text display	Digital selector <b>No selection</b>	Digital signal (high active) for activating the text display in the top line (line 3)
Bottom text display	Digital selector <b>No selection</b>	Digital signal (high active) for activating the text display in the bottom line (line 4 or line 2)





## 7.5 Analog input

The device has a universal analog input for connecting various measuring probes (sensors).

## 7 Configuration

Parameter	Selection/text/value	Description	
Signal type	No sensor	No sensor selected	
	2L RTD temperature probe	RTD temperature probe in two-wire circuit	
	<b>3L RTD temperature probe</b>	RTD temperature probe in three-wire circuit	
	2L resistance/potentiometer	Resistance/potentiometer in two-wire circuit	
	3L resistance/potentiometer	Resistance/potentiometer in three-wire circuit	
	Resistance transmitter	Resistance transmitter	
	Thermocouple	Thermocouple	
	0...10 V	Voltage signal	
	2...10 V	Voltage signal	
	0...20 mA	Current signal	
	4...20 mA	Current signal	
Linearization	<b>Pt100</b>	Only with RTD temperature probe	
	GOST Pt100		
	Pt1000		
	KTY two-wire		
	L / Fe_CuNi	Only with thermocouple	
	J / Fe_CuNi		
	U / Cu-CuNi		
	T / Cu-CuNi		
	K / NiCr-Ni		
	E / NiCr-CuNi		
	N / NiCrSi-NiSi		
	S / Pt10Rh-Pt		
	R / Pt13Rh-Pt		
	B / Pt30Rh-Pt6Rh		
	C / W5Re-W26Re		
	D / W3Re-W25Re		
	A1 / W5Re-W20Re		
	L / Chromel®-Copel®		
	Chromel®-Alumel®		
	Linear		Only with resistance/potentiometer, resistance transmitter, voltage, current
	Customer-specific	Customer-specific linearization with 4th order polynomial or grid points (configurable with setup program)	
	Temperature		Only with resistance/potentiometer, resistance transmitter, voltage, current: This selection is important for the automatic conversion in case of a change in temperature unit (°C/°F) (see system data).
		<b>None</b>	The value is not a temperature.
Relative		The value is a temperature difference.	
Absolute		The value is a temperature value.	

## 7 Configuration

Parameter	Selection/text/value	Description
Unit (setup only)	<Enter text> %	Value unit (if it is not a temperature)
Resistance measuring range	0...400 $\Omega$ <b>0...4000 <math>\Omega</math></b>	Measuring range for resistance/potentiometer and RTD temperature probe with customer-specific linearization
Resistance Ra or R0 	<b>0</b> to 4000 ( $\Omega$ )	For resistance transmitter: Resistance Ra between slider (S) and start (A), if the slider is positioned at the start. For resistance/potentiometer: Offset resistance Ro
Resistance Rs or Rx 	0 to 4000 ( <b>1000</b> ) ( $\Omega$ )	For resistance transmitter: Resistance range Rs of the slider For resistance/potentiometer: Shifting resistance range Rx
Resistance Re 	<b>0</b> to 4000 ( $\Omega$ )	For resistance transmitter: Resistance Re between slider (S) and end (E), if the slider is positioned at the end.
Scaling start	-1999 to 9999 ( <b>0</b> )	Lower limit of measuring range or display range (depending on sensor and linearization)
Scaling end	-1999 to 9999 ( <b>100</b> )	Upper limit of measuring range or display range (depending on sensor and linearization)
Decimal places		Number of pre-decimal and decimal places for the numerical display of the measured value
	<b>Auto</b>	Automatic
	XXXX.	No decimal place
	XXX.X	One decimal place
	XX.XX	Two decimal places
	X.XXX	Three decimal places
Measured value offset	-1999 to 9999 ( <b>0</b> )	Correction value for the measured value All measured values are moved by the same correction value (see fine adjustment).
Filter time constant 	0 to 100 ( <b>0.6</b> )	Time constant (in seconds) for adjusting the digital input filter (0 s = filter off)
KTY at 25 °C (setup only)	0 to 4000 ( <b>2000</b> )	For 2-L RTD temperature probe with linearization KTY11-6 2-L: resistance (in $\Omega$ ) at 25 °C / 77 °F
Cold junction temperature (setup only)		Only with thermocouple: selection of the cold junction temperature
	<b>Internal</b>	Internal temperature is used.
	Constant	Constant temperature can be entered.
Constant (setup only)	0 to 100 ( <b>25</b> )	Constant cold junction temperature
Fine adjustment (device only) 	<b>Off</b>	The function for performing fine adjustment is not active. This function is available in the setup program under "Online parameter".
	On	The function is active.

Parameter	Selection/text/value	Description
Actual start value	-1999 to 9999 ( <b>0</b> )	Fine adjustment: device measured value at the lower measuring point  In contrast to measured value offsetting, which is used to specify a constant correction value for the entire characteristic line, fine adjustment can also be used to change the gradient of the characteristic line.
Actual end value	-1999 to 9999 ( <b>100</b> )	Fine adjustment: device measured value at the upper measuring point
Target start value	-1999 to 9999 ( <b>0</b> )	Fine adjustment: reference value at the lower measuring point
Target end value	-1999 to 9999 ( <b>100</b> )	Fine adjustment: reference value at the upper measuring point
Additional functions (setup only)	Expansion 1 to expansion 5	Reserved functions for service purposes. Only activate when instructed to do so by service personnel!  Click checkbox to activate the function.



**NOTE!**

The analog input can only be used as an alternative to digital input 2 with signal type 0(2) up to 10 V.

**Resistance Ra or Ro, Rs or Rx, Re**

The overall resistance  $R_a + R_s + R_e$  (or  $R_o + R_x$ ) must not exceed 4000  $\Omega$ .

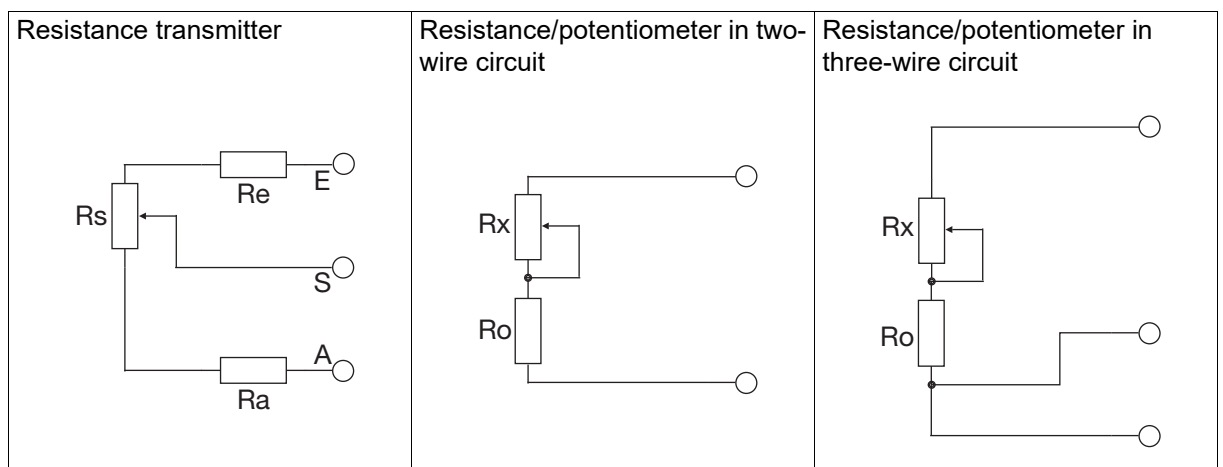

**Filter time constant**

The filter time constant is used to adjust the digital input filter (2nd order filter). If the input signal changes suddenly, approx. 26 % of the change is recorded following a period that corresponds to the filter time constant (2 × filter time constants: approx. 59 %; 5 × filter time constants: approx. 96 %). A large filter time constant means: high attenuation of interference signals, slow reaction to the actual value display, low limit frequency (low-pass filter).

**7.5.1 Fine adjustment**

You can use this function to correct the measured values of the analog input. In contrast to measured value offsetting, which is used to specify a constant correction value for the entire characteristic line, fine adjustment can also be used to change the gradient of the characteristic line.

# 7 Configuration

---

## Example

The temperature inside a furnace is measured with an RTD temperature probe connected to the device. The measured value displayed by the device deviates from the actual temperature as a result of the sensor temperature drifting. The amount of deviation is different at the lower measuring point (start value) and at the upper measuring point (end value), meaning a measured value offset correction is not suitable. The actual temperature (reference value) is determined using a reference measuring device.

Actual start value: 15 °C (measured value)

Target start value: 20 °C (reference value)

Actual end value: 70 °C (measured value)

Target end value: 80 °C (reference value)

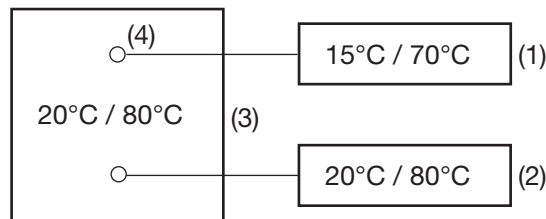

- 1 Display values
- 2 Reference values
- 3 Furnace
- 4 Sensor in RTD temperature probe

## Performing fine adjustment

- 1) Switch off fine adjustment.
- 2) Run up first working point (lower measuring point, value as low and constant and possible). Read the measured value on the device, read the reference value on the reference measuring device. Note both values.
- 3) Run up second working point (upper measuring point, value as high and constant and possible). Read the measured value on the device, read the reference value on the reference measuring device. Note both values.
- 4) Switch on fine adjustment, enter device's measured values from the first and second working point (actual start value (15.0) and actual end value (70.0)); then enter the reference measuring device's reference values from the first and second working point (target start value (20.0) and target start value (80.0)).

The following diagram shows the changes in the characteristic line caused by the measured value offset (point of intersection with the x axis as well as the gradient) based on the values from the example above (x = reference value, Y = display value).

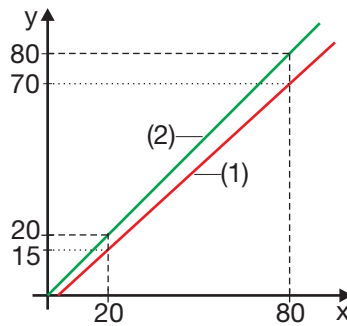

- 1 Characteristic line before fine adjustment
- 2 Characteristic line after fine adjustment



## Reverse fine adjustment

The following settings must be made to reverse the fine adjustment: actual start value = target start value; actual end value = target end value

Switching off fine adjustment leads to this being reversed.

## 7.6 Analog output

The device can optionally be equipped with an analog output.

Category	Signal	Description
Source	Analog selector <b>No selection</b>	Analog signal that is issued on the analog output. In the event of "No selection" a voltage of 0 V or 0 mA is output (depending on the signal type).
Signal type		Physical output signal
	<b>0...10 V</b>	Voltage signal
	0...20 mA	Current signal
	4...20 mA	Current signal
2...10 V	Voltage signal	
Scaling start 	-1999 to 9999 ( <b>0</b> )	Start value of the input signal range
Scaling end 	-1999 to 9999 ( <b>100</b> )	End value of the input signal range
Response in case of a fault 		Value of the output signal in case of a fault
	<b>Replacement value</b>	Configurable value (see "Replacement value" parameter)
	Low value	Fixed value for measuring range underflow/short-circuit
	High value	Fixed value for measuring range overflow/probe break
Replacement value	<b>0</b> to 10 V or <b>0</b> to 20 mA	Replacement value for the output signal in the event of a fault (value range depending on the signal type)

# 7 Configuration

## Scaling start, scaling end

An input signal range is assigned to the physical output signal range by scaling. If, for example, a temperature with a range from 150 °C to 500 °C (input signal range) is issued via the analog output with signal type 0 to 20 mA (output signal range), the zero point is set to 150 (corresponds to 0 mA) and the end value is set to 500 (corresponds to 20 mA).

The default setting corresponds to an input signal range of 0 to 100 (for example, an output level of 0 % to 100 % for a controller output).

The following graphic shows the scaling for the example above with different output signals (y-axes).

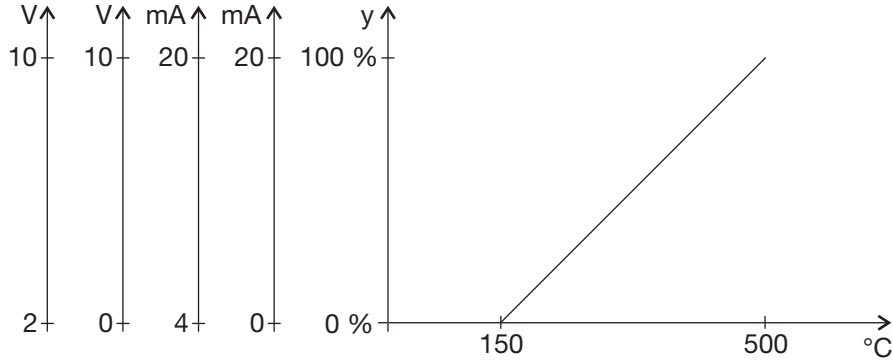

## Response in case of a fault

The behavior in the event of deviation above or below the measuring range (out of range) can be configured. The settings made there also apply for probe/conductor breaks or probe/conductor short-circuits. This results in a safe state for operation in the event of a fault.

The following table shows the fixed values that are output in the event of a fault - with the corresponding configuration. The specifications in brackets are limits that apply according to NAMUR recommendation NE 43.

Signal type	Low value	High value
0 to 10 V	0 V	10.7 V
0 to 20 mA	0 mA	22 mA
4 to 20 mA	3.4 mA ( $\leq 3.6$ mA)	22 mA ( $\geq 21$ mA)
2...10 V	1.7 V ( $\leq 1.8$ V)	10.7 V ( $\geq 10.5$ V)

## Behavior after power on

A voltage of 0 V is output during the device's initialization phase (depending on the configuration). Once the initialization is complete, the output signal depends on the signal of the source and the configured signal type.

## 7.7 Digital inputs

The device is equipped with two digital inputs that are provided to connect a potential-free contact.

Parameter	Selection/text/value	Description
Inversion	No	Input signal not inverted.
	Yes	Input signal inverted.



### NOTE!

Digital input 1 can only be used as an alternative to digital input 3. If digital input 3 (logic output 0/14 V) is activated by assigning a signal source, digital input 1 is inactive.





**NOTE!**

Digital input 2 can only be used if the analog input has not been configured with signal types 0 up to 10 V, 2 up to 10 V, or "No sensor".

## 7.8 Digital outputs

The device has a digital output (logic output 0/14 V) and up to two relay outputs (normally open contact). On top of that, up to four additional digital outputs are optionally available depending on the device type (relay, logic 0/14 V, PhotoMOS relay).

Parameter	Selection/text/value	Description
Source	Digital selector	Signal that is issued at the digital output.
	<b>No selection</b>	Default setting for digital output 1: <b>controller output 1 (digital)</b> In the event of "No selection" the output signal does not correspond to the active status.
Inversion	<b>No</b>	Output signal not inverted.
	<b>Yes</b>	Output signal inverted.



**NOTE!**

Digital input 3 can only be used as an alternative to digital input 1. If digital input 3 (logic output 0/14 V) is activated by assigning a signal source, digital input 1 is inactive.

### Behavior after power on

The outputs are not active during the device's initialization phase (depending on the configuration). Once the initialization is complete, the output signal corresponds to the signal of the source (inverted if necessary).



## 7.9 Controller

### 7.9.1 Controller configuration

The general features of the controller are defined in this menu.

Parameter	Selection/text/value	Description
Controller type 	Off	Controller disabled
	<b>2-P controller</b>	Two-state controller Controller with a switched output
	3-P controller	Three-state controller Controller with two switched outputs (for example, for heating/cooling) The combination of a continuous (e.g., for heating) and a switched output (e.g., for cooling) is also possible.
	3-P step controller	Three-step controller Controller with two switched outputs (for motor actuator)
	Continuous controller	Continuous controller Controller with a continuous output (analog signal)

# 7 Configuration

Parameter	Selection/text/value	Description
Control direction	Direct	The controller output level is positive if the actual value is greater than the setpoint value (cooling).
	<b>Inverse</b>	The controller output level is positive if the actual value is smaller than the setpoint value (heating).
Manual mode (setup only)	<b>Enabled</b>	Changeover to manual mode possible (through button operation or digital signal)
	Inhibited	Changeover to manual mode is inhibited.
Y in manual mode 		Output level after changeover to manual mode
	<b>Current value</b>	Current output level before changeover
	Y manual mode	Configurable value (see "Y manual mode" parameter)
Y manual mode	-100 to +100 ( <b>0</b> )	Output level (in percent) in manual mode
Y with error 		Output level in the event of a fault (outside of the measuring range)
	Current value	Current output level before fault occurs
	<b>Y replacement value</b>	Configurable value (see "Y replacement value" parameter)
Y replacement value	-100 to +100 ( <b>0</b> )	Output level (in percent) in the event of a fault
Additional functions (setup only)	Parameter 1 to parameter 4	Reserved function for service purposes. Only activate when instructed to do so by service personnel!  Click checkbox to activate the function.

## Controller type

Description of the controller types:

⇒ chapter 6.2 "Controller types", Page 43

## Y in manual mode, Y with error

For modulating controller:

- Current value: actuator is stationary
- 0: actuator closes
- 100: actuator opens

## Behavior after power on

The controller outputs are inactive during the initialization phase (output level 0 %, relay in standby mode).

## 7.9.2 Controller input

The controller input signals are assigned in this menu.

Parameter	Selection/text/value	Description
Controller actual value	Analog selector <b>Analog input</b>	Analog signal as actual value of the controller
Controller setpoint value	Analog selector <b>Current setpoint value</b>	Analog signal as controller setpoint value
Signal 1 setpoint changeover	Digital selector <b>No selection</b>	Signal (bit 0) for controlling setpoint changeover

Parameter	Selection/text/value	Description
Signal 2 setpoint changeover	Digital selector <b>No selection</b>	Signal (bit 1) for controlling setpoint changeover
Manual/auto changeover signal	Digital selector <b>No selection</b>	Signal (high-active) for changeover to manual mode
Manual mode signal inhibition	Digital selector <b>No selection</b>	Signal (high active) for inhibiting manual mode
Parameter block changeover signal	Digital selector <b>No selection</b>	Signal (high-active) for changeover from parameter block 1 to parameter block 2
Controller signal on	Digital selector <b>No selection</b>	Signal (high-active) for switching on the controller
Controller signal off	Digital selector <b>No selection</b>	Signal (high-active) for switching off the controller

## Setpoint changeover

Signal 2 (bit 1)	Signal 1 (bit 0)	Active setpoint value
0	0	Setpoint value 1
0	1	Setpoint value 2
1	0	Setpoint value 3
1	1	Setpoint value 4

## 7.9.3 Autotuning

This menu is used to implement settings for the autotuning.



### WARNING!

During autotuning according to the oscillation method, output level limits Y1 and Y2 are not active for switched outputs or solid state outputs.

The output level may exceed or fall below the set limits.

- It must be ensured that this does not result in damage to the plant.

Parameter	Selection/text/value	Description
Method 	Step response	Step response method
	<b>Oscillation</b>	Oscillation method
Inhibit (setup only)	<b>Enabled</b>	Autotuning is enabled.
	Inhibited	Autotuning is inhibited.
Controller output type 1		Type of the first controller output The cycle time is calculated on the basis of the type of controller output.
	<b>Automatic</b>	Automatic setting based on the configuration If the controller output signal is assigned to several digital outputs (e.g., output 1: relay; output 4: logic), the digital output with the smaller number is relevant (here: output 1).
	Relay	Relay output
	Analog	Analog output
	Solid state/logic	PhotoMOS® relay output or logic output

# 7 Configuration

Parameter	Selection/text/value	Description
Controller output type 2	(like output type 1)	Type of the second controller output (for three-state controller)
Standby output	-100 to +100 ( <b>0</b> )	Output level (in percent) at start of autotuning for step response method
Step size	10 to 100 ( <b>30</b> )	Size of output level step (in percent) for step response method
Application of switching period		Application of Cy cycle time after completion of autotuning
	Off	The determined value will not be applied.
	On	The determined value will be applied.
Start/stop signal	Digital selector <b>No selection</b>	Signal (active for rising edge) for starting and stopping autotuning Autotuning is started by a rising edge. If autotuning is active, it is stopped by a rising edge.
Inhibit signal	Digital selector <b>No selection</b>	Signal (high-active) for inhibiting autotuning

## Method

The standard method is the oscillation method, whereas the step response method is used specifically in the plastics industry. With the oscillation method, the output level is set alternately to 100 % and 0 %, which produces oscillation of the control variable. With the step response method, a step of a specified size is made from the standby output. In both cases, the controller determines the optimum controller parameters from the response of the actual value.

## Optimization according to the oscillation method

In the case of a large control deviation between the setpoint value and actual value (for example, in the startup phase), the controller determines a switching line around which the control variable performs a forced oscillation during autotuning. The switching line is determined so that the actual value does not exceed the setpoint value if possible.

In the case of minor control deviation (e.g. if the control loop is in a steady state during operation), oscillation is forced around the setpoint value. Here, the setpoint value is exceeded in any case.

The controller automatically chooses between two procedures depending on the extent of the control deviation:

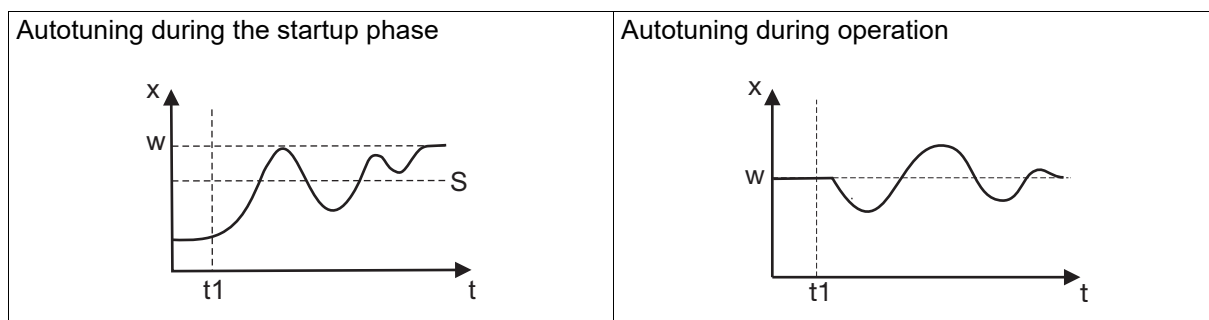

x = actual value  
S = switching line

w = setpoint value  
t1 = start of autotuning

## Optimization according to the step response method

Initially, a configurable standby output is produced until the actual value "settles" to a constant. This is automatically followed by a configurable output level step (step size) to the control process.

# 7 Configuration

Main applications of the step response method:

- Optimization immediately after "power on" during startup (considerable time saving, standby output setting = 0 %)
- Control process does not oscillate easily (for example, extremely well insulated furnace with low losses, long oscillation period)
- Actual value must not exceed the setpoint value  
If the output level is known for the corrected setpoint value, overshooting is prevented with the following setting:  
Standby output + step size  $\leq$  output level in corrected state

The progression of the output level and actual value depends on the status of the process at the point when autotuning starts:

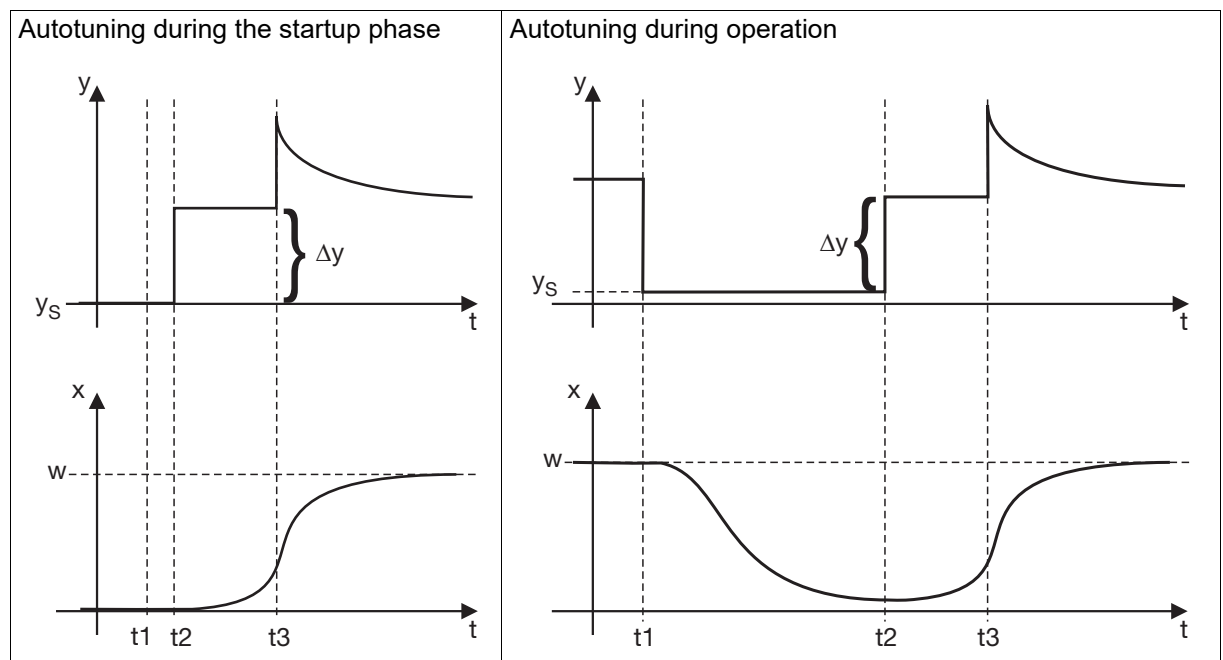

y = output level  
 $y_s$  = standby output  
 x = actual value  
 w = setpoint value

$\Delta y$  = step size  
 t1 = start of autotuning  
 t2 = time of output level step  
 t3 = end of autotuning

## Optimized controller parameters

With both autotuning methods, the parameters for PI or PID controller structure are optimized according to the configured controller type and the configured "Control structure" parameter: proportional band  $X_p$  (P component), derivative time  $T_v$  (D component), and reset time  $T_n$  (I component).

The cycle time  $C_y$  and the filter time constant  $dF$  are also optimized.

Configured controller type	Configured parameter	Optimized parameters	Optimized control structure
Two-state controller	Control structure 1 = PI	$X_{p1}$ , $T_{n1}$ , $C_{y1}$ , $dF$	PI
	All other settings	$X_{p1}$ , $T_{v1}$ , $T_{n1}$ , $C_{y1}$ , $dF$	PID
Three-state controller	Control structure 1 = PI or control structure 2 = PI	$X_{p1}$ , $X_{p2}$ , $T_{n1}$ , $T_{n2}$ , $C_{y1}$ , $C_{y2}$ , $dF$ ; ( $T_{v1}/2 = 0$ )	PI
	All other settings	$X_{p1}$ , $X_{p2}$ , $T_{v1}$ , $T_{v2}$ , $T_{n1}$ , $T_{n2}$ , $C_{y1}$ , $C_{y2}$ , $dF$	PID
Three-step controller	Control structure 1 = PI	$X_{p1}$ , $T_{n1}$ , $dF$	PI

# 7 Configuration

Configured controller type	Configured parameter	Optimized parameters	Optimized control structure
	All other settings	Xp1, Tv1, Tn1, dF	PID
Continuous controller	Control structure 1 = PI	Xp1, Tn1, dF	PI
	All other settings	Xp1, Tv1, Tn1, dF	PID

The configured control structure is not changed by the optimization if it is a PI or PID control structure. In all other cases, it is optimized to PID control structure.

For 1st order control processes, the parameters required for the PI control structure are optimized, independently of the "Control structure" configured parameter.

## Requirements for autotuning

The following aspects must be considered before starting autotuning:

- Is the suitable controller type configured?
- Check and/or adjust the control action of the controller.
- Is it possible to sufficiently influence the process value in manual mode?
- For a three-step controller, the actuator time (tt) must be determined and adjusted in the parameterization.

## Starting autotuning

Autotuning is started by long-pressing the "Up" and "Down" buttons at the same time for at least 5 s. The ongoing autotuning is also stopped (aborted) in the same way.

With the corresponding configuration, autotuning can also be started or stopped by pressing the "Back" button or through a digital signal. To do so, the controller must not be in manual mode and autotuning must not be inhibited.

A corresponding reference text appears on the display while autotuning is running. Autotuning is completed when the display automatically changes to the basic status. The duration of autotuning depends on the process.



### NOTE!

Autotuning must be performed under real operating conditions; it can be performed any number of times.



### NOTE!

If the actual value leaves the measuring range during autotuning, the autotuning process is aborted. In this case, the configured parameters are not changed.

## 7.9.4 Control loop monitoring (setup only)

Control loop monitoring monitors the control response during startup of a plant and in the event of a set-point step by analyzing the change of the actual value during an output level change. The alarm signal is activated if the actual value does not respond according to the specifications.

Parameter	Selection/text/value	Description
Function	<b>Off</b>	Control loop monitoring is not active.
	On	Control loop monitoring is active.
Response time	0 to 9999	Time period (in seconds) in which the actual value must leave the monitoring band. "0" setting means: Response time = reset time Tn

# 7 Configuration

Parameter	Selection/text/value	Description
Monitoring band	0 to 9999	Range that the actual value must leave within the response time. "0" setting means: Monitoring band = $0.5 \times$ proportional band ( $X_p$ )

## Description of the function

Monitoring starts as soon as the maximum output level is produced in heating mode (see example) or as soon as the minimum output level is produced in cooling mode. Starting from this point, the actual value must leave the monitoring band – the range around the current value at the start of monitoring – within the response time. If it is not, the alarm signal is activated.

On leaving the monitoring band, the actual value at the time is used as a reference value for a new monitoring band. The response time starts over.

Monitoring ends as soon as the maximum or minimum output level is no longer produced.

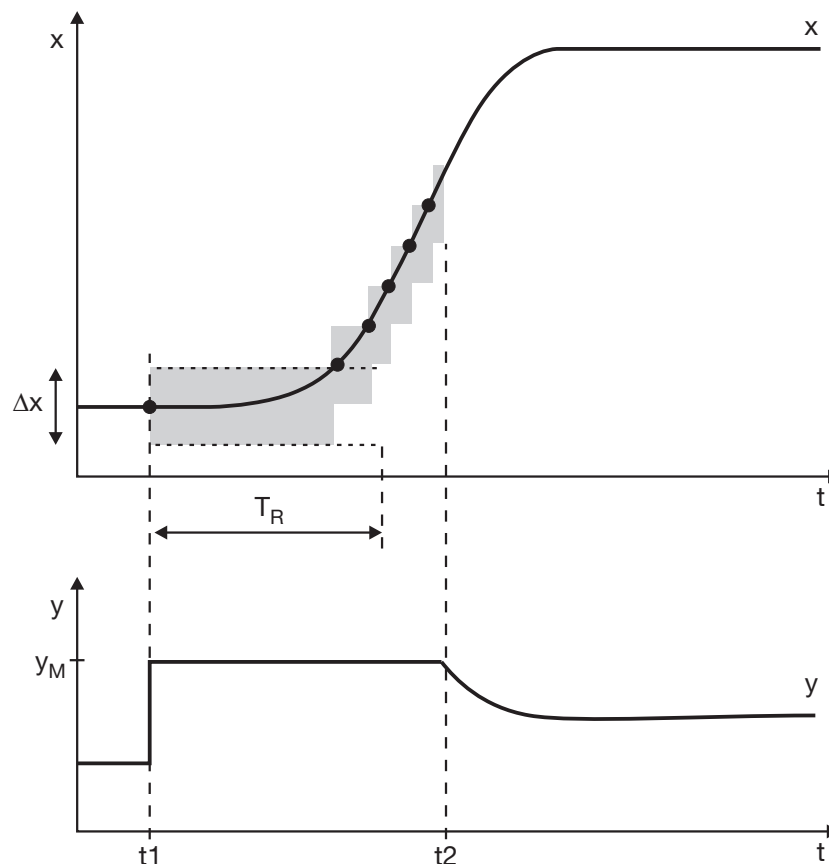

x	Actual value	$\Delta x$	Monitoring band
y	Output level	$y_M$	Max. output level (for example, 100 %)
t1	Start of monitoring	$T_R$	Response time
t2	End of monitoring		

If the actual value does not leave the monitoring band within this timeframe, an alarm signal is generated. The alarm signal is maintained for as long as the maximum or minimum output level is produced and the actual value is within the monitoring band.

# 7 Configuration

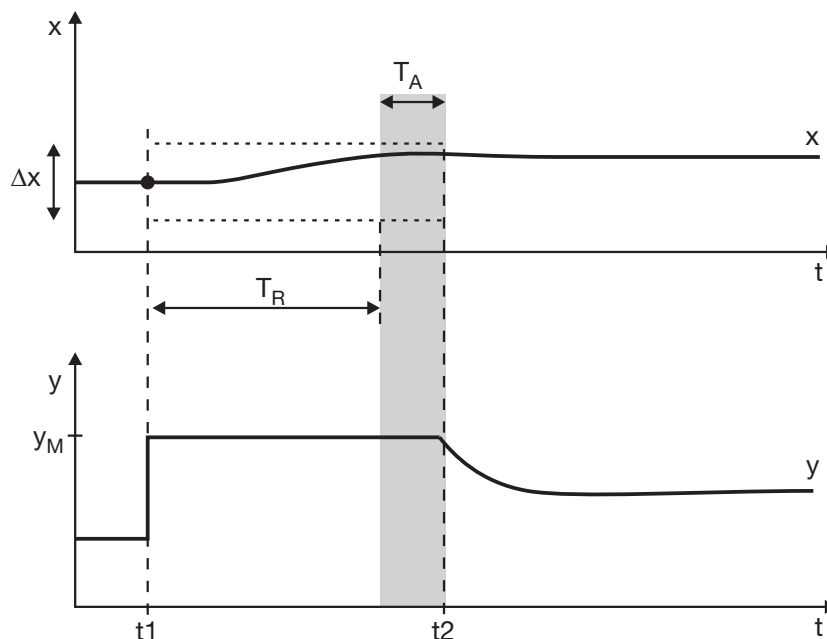

x	Actual value	$\Delta x$	Monitoring band
y	Output level	$y_M$	Max. output level (for example, 100 %)
t1	Start of monitoring	$T_R$	Response time
$T_A$	Alarm period	t2	End of monitoring

An alarm may be caused by:

- Partial or total failure of heating elements or other parts in the control loop
- Reversal of the control direction (for example, "direct" instead of "inverse")

## Functional limitations

The control loop monitoring is not active in the following cases:

- Autotuning active
- Manual mode
- Output level is not at its maximum limit (heating mode) or minimum limit (cooling mode)

## Parameter dimensioning

The controller parameters must be optimally adjusted for the control loop monitoring to function correctly, e.g. using autotuning. If alarms occur temporarily, despite the plant operating correctly, either the **response time** must be increased, or the **monitoring band** must be narrowed. To do this, plot the approach curve, e.g. with the startup function of the setup program.

### 7.9.5 Output level monitoring (setup only)

Output level monitoring monitors the output level in the corrected state. The output level must be within a definable range around a mean output level. If it is not, the alarm signal is activated.

Parameter	Selection/text/value	Description
Function	Off	Output level monitoring is not active.
	On	Output level monitoring is active.
Determination time	0 to 9999 (350)	Calculation time (in seconds) for the mean output level



# 7 Configuration

Parameter	Selection/text/value	Description
Output level band	0 to 100 (10)	Monitored output level band (admissible range around the mean output level)
Alarm delay	0 to 9999	Delay time (in seconds) for alarm triggering
Controller differential band	0 to 9999 (1)	Controller differential band (admissible range around the actual value in corrected state)

## Description of the function

Once the output level monitoring has been activated, determination of the mean output level starts as soon as the actual value is within the controller differential band. When the mean output level has been determined, the current output level must be within the monitored output level band. If it is not, the alarm signal is activated.

In the event of a setpoint value change, output level monitoring is temporarily deactivated until the actual value returns to the control differential band. The mean output level is then determined again.

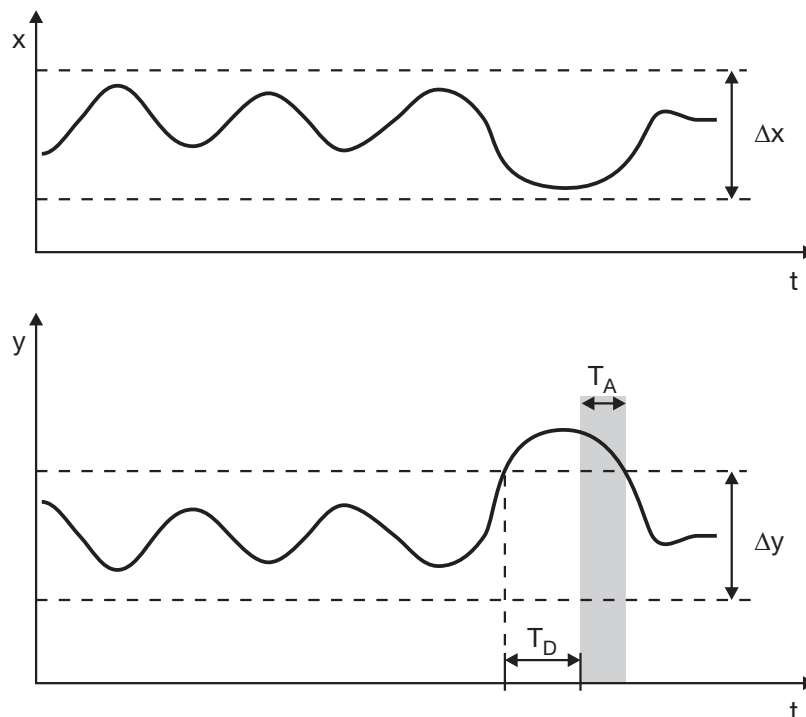

$x$  Actual value

$y$  Output level

$T_D$  Alarm delay

$\Delta x$  Controller differential band

$\Delta y$  Monitored output level band

$T_A$  Alarm period

Application examples:

- Monitoring of faults on heating elements
- Reporting of faults during operation

# 7 Configuration

## Functional limitations

Output level monitoring is not active in the following cases:

- Proportional band  $X_p = 0$
- Autotuning active
- Manual mode
- Ramp function active
- Controller operating as program controller

## Parameter dimensioning

Appropriate dimensioning of parameters used for determining the mean output level is required for the output level monitoring to function correctly.

The **controller differential band** around the actual value defines the corrected state. It should be dimensioned so that it is adhered to during normal operation. The progression of the actual value can, for example, be recorded with the startup function of the setup program. Determination of the mean output level starts when the actual value enters the control differential band. Calculation of the mean output level starts over if there is temporary deviation from the control differential band during output level determination or if the setpoint value is changed by more than  $0.5 \times$  control differential band  $\Delta x$ .

A mean output level is calculated via the **determination time** using a moving average. The time chosen should be long enough to ensure as accurate a calculation as possible. The determination time is followed by a waiting period of  $0.5 \times$  reset time  $T_n$ , during which it is checked whether the actual value and output level move within the specified limits. If one of the limits is exceeded, the calculation restarts. After successful calculation, the output level monitoring is active.

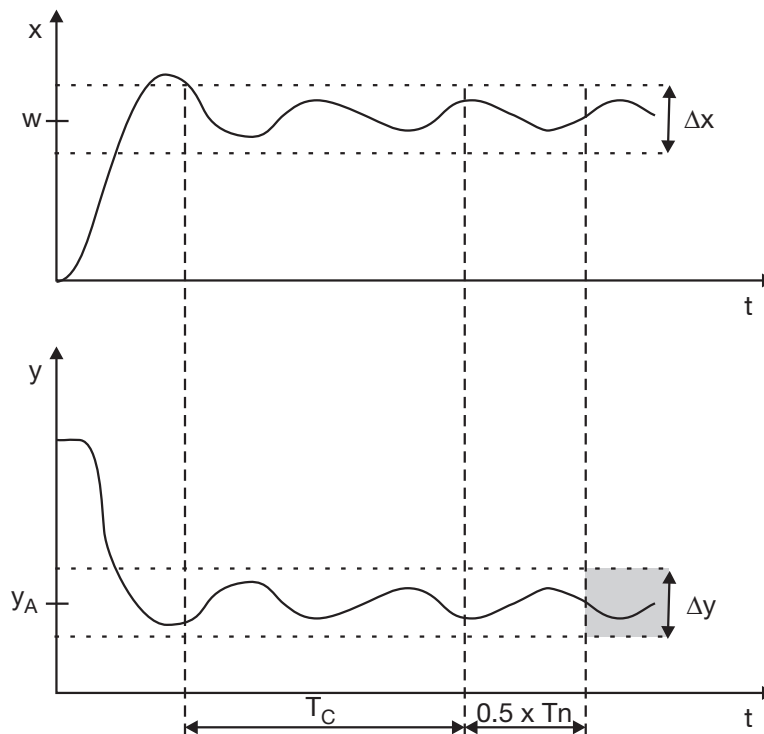

x	Actual value	w	Setpoint value
y	Output level	$y_A$	Average output level
$T_C$	Determination time	rt	Reset time
$\Delta y$	Output level band	$\Delta x$	Controller differential band

## 7.9.6 Setpoint values

One of four (switchable) setpoint values is used as a controller setpoint value. For each of these setpoints, certain specifications can be made here that are of importance, for example, when entering the setpoint value. The setpoint itself can also be set here.

Parameter	Selection/text/value	Description
Min. limit	-1999 to 9999	Minimum admissible setpoint value (lower input limit)
Max. limit	-1999 to 9999	Maximum admissible setpoint value (upper input limit)
Setpoint value	-1999 to 9999 (0)	Fixed setpoint value (input limits dependent on min. limit and max. limit)

## 7.9.7 Ramp function

The ramp function is used for a constant change of setpoint value  $w$ , starting from the current ramp value (= actual value at time  $t_0$  of the setpoint value change) up to the ramp end value SP (default setpoint value).

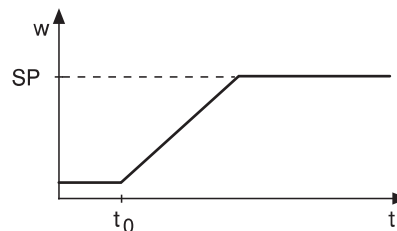

A tolerance band can be set around the setpoint value curve to monitor the actual value. If the actual value deviates from the tolerance band, the tolerance band signal is activated and the ramp is stopped.



### NOTE!

If the device operates as a program controller, the ramp function is not active.



### NOTE!

The ramp function is not active in manual mode. After switching from manual mode to automatic mode, the actual value is applied as the current ramp value (ramp starts).

Parameter	Selection/text/value	Description
Function	Off	Ramp function is not active.
	Per minute	Ramp function is active. Unit of ramp slope: Kelvin per minute
	Per hour	Kelvin per hour
	Per day	Kelvin per day
Pos. gradient	0 to 999	Value for positive ramp slope
Neg. gradient	0 to 999	Value for negative ramp slope
Tolerance band	0 to 9999	Amount of admissible upward and downward deviation of the actual value (standard tolerance band around setpoint value)
Stop signal	Digital selector No selection	Signal (high active) for stopping the ramp (setpoint value remains constant at the current value)

## 7 Configuration

Parameter	Selection/text/value	Description
Off signal	Digital selector <b>No selection</b>	Signal (high active) for switching off the ramp function (setpoint value immediately assumes the specified end value)
Restart signal	Digital selector <b>No selection</b>	Signal (high-active) for aborting and restarting the ramp (with actual value as setpoint value)
Additional functions (setup only)	Parameter 1 parameter 2	Reserved functions for service purposes. Only activate when instructed to do so by service personnel! Click checkbox to activate the function.



### Response in case of a fault

In the event of a fault (above or below the measuring range, probe/conductor breaks or probe/conductor short-circuits), the ramp function is interrupted. Once the fault is over, the actual value is applied as the current ramp value.

### Behavior after power on

After power on, the actual value is applied as the current ramp value (ramp starts).

## 7.10 Program controller

Parameter	Selection/text/value	Description
Function 	<b>Fixed-setpoint controller</b>	The device operates as a fixed-setpoint controller ("Fixed value" operating mode).
	Program controller	The device operates as a program controller ("Automatic" and "Stop" operating modes).
Time display		Time unit for displaying the program times
	<b>mm:ss</b>	Minutes:Hours
	hh:mm	Hours:Minutes
	dd:hh	Days:Hours
Program start	<b>Program start</b>	The program starts at the first programmed setpoint value.
	Actual value	The programs starts with the actual value as the first setpoint value.
Start with power on (setup only)	<b>No</b>	No automatic program start after power on
	Yes	Automatic program start after power on
Lead time (setup only)	<b>0</b> to 9999	Delay time (in seconds) for program start
Tolerance band 	<b>0</b> to 9999	Tolerance band around setpoint value (for monitoring the setpoint value) 0 = tolerance band not active
Program repeat (setup only)	<b>No</b>	No program repeat
	Yes	The program is cyclically repeated.
Program progression step	<b>No</b>	Setpoint value change as ramp
	Yes	Setpoint value change as step
Actual value input	Analog selector <b>Analog input</b>	Analog signal as actual value of the controller

Parameter	Selection/text/value	Description
Operating contacts basic status (setup only)	Contact 1 to contact 4	These operating contact are used if the program is not running (program controller in basic status). Click checkbox to activate the contact.
	<b>Not selected (empty)</b>	Operating contact is not active.
	Selected (checkmark)	Operating contact is active.
Start signal	Digital selector <b>No selection</b>	Signal (active for rising edge) to start the program
Stop signal	Digital selector <b>No selection</b>	Signal (high active) for stopping the program
Abort signal	Digital selector <b>No selection</b>	Signal (active for rising edge) to end the program (program abort)
Next section signal	Digital selector <b>No selection</b>	Signal (active for rising edge) to switch to the next program section
Additional functions (setup only)	Parameter 1 to parameter 4	Reserved functions for service purposes. Only activate when instructed to do so by service personnel! Click checkbox to activate the function.

## Function

Operating modes of the program controller:

- Fixed value: The device operates as a fixed-setpoint controller
- Automatic: The device operates as a program controller. The program is active and is being processed.
- Stop: The device operates as a program controller. The program is active, but has been stopped.



### NOTE!

Before program start, during the lead time, and after program end, the device operates as a fixed-setpoint controller. If the control is not to be active in this phase, the controller must only be switched on during the active program. The "Program active" signal can be used for this purpose:

Configuration > Controller > Controller input > Controller on signal: Program > Program active

## Tolerance band

In the "Automatic" and "Stop" operating modes when the tolerance band is active, it is continuously checked whether the actual value is within the tolerance band. If the actual value deviates from the tolerance band, the tolerance band signal is activated.

If the tolerance band signal is to be used to stop the program (hold-back function), this function must be configured:

Configuration > Program controller > Control signals > Stop signal: Program > Tolerance band signal (program)Programm



### NOTE!

The tolerance band is symmetrical to the setpoint value and applies to all program sections. Other functions can be implemented by using the limit value monitoring functions and the control contacts (logical conjunction as a digital control signal).

Example: Hold-back-Funktion nur im ersten Programmabschnitt und nur, wenn der Istwert den Sollwert um einen bestimmten Wert unterschreitet (limit value monitoring with function AF4, control contact ON during the first program section, AND conjunction of the two signals as a digital control signal for stopping the program)

# 7 Configuration

The tolerance band is not active in the "Fixed value" operating mode - and during the lead time and after program end.

## Behavior after power on

The current program status is not saved via power off. The behavior is configurable after power on (automatic start).

## 7.11 Timer

The device has a timer that can be used to implement various, time-dependent functions.

Parameter	Selection/text/value	Description
Function	<b>Off</b>	Timer is not active.
	On	Timer is active
Behavior after power on (setup only)	<b>Abort</b>	Timer aborted
	Continuation	Timer continues to run for the remaining running time. Any minute of remaining running time that is not completed is repeated; examples (mm:ss): power off at 09:01, continuation at 10:00 power off at 09:00, continuation at 09:00
	Restart	Timer restarts at the timer time. The lead time is not considered in case of a restart.
Time display		Timer time unit (for input and display on the device)
	<b>mm:ss</b>	Minutes:Seconds
	hh:mm	Hours:Minutes
	dd:hh	Days:Hours
Timer time	<b>00:00</b> to 59:59 <b>00:00</b> to 23:59 <b>00:00</b> to 99:23	Time after timer start The setting range depends on the configured time unit: mm:ss hh:mm dd:hh
Lead time	<b>0</b> to 9999	Time before timer start (in seconds)
End time (after-run time)	-1 to 9999 ( <b>0</b> )	Time after timer end (in seconds) -1 = active until acknowledged The end signal is active during the after-run time.
Acknowledgement signal	Digital selector <b>No selection</b>	Only if after-run time $\neq$ 0: signal (active for rising edge) to acknowledge the end signal
Start signal	Digital selector <b>No selection</b>	Signal (active for rising edge) to start the timer The start signal only works while the timer is not running or during the after-run time (not during the lead time or runtime).
Abort signal	Digital selector <b>No selection</b>	Signal (active for rising edge) to abort the timer The abort signal only works during the runtime (not during the lead time or after-run time).
Stop signal	Digital selector <b>No selection</b>	Signal (high active) for stopping the timer The stop signal only works during the lead time and runtime (not during the after-run time).

Parameter	Selection/text/value	Description
Restart signal	Digital selector <b>No selection</b>	Signal (active for rising edge) to reset and restart the timer  The restart signal only works during the runtime (not during the lead time or after-run time); it cannot be used to start the timer.  The lead time is not considered in case of a restart.
Output signal	<b>High active</b>	Output signal: high active while timer is running
	Low active	Output signal: low active while timer is running
Tolerance band	<b>0</b> to 9999	Standard tolerance band (in Kelvin) around the setpoint value  After the timer is started, the timer time only runs from the point in time when the actual value reaches the tolerance band.  0 = Start without tolerance band
Tolerance band actual value	Analog selector <b>No selection</b>	Actual value for tolerance band function
Tolerance band setpoint value	Analog selector <b>No selection</b>	Setpoint value for tolerance band function
Additional functions (setup only)	Expansion 1	Reserved function for service purposes. Only activate when instructed to do so by service personnel!  Click checkbox to activate the function.

## Timer signals

**Timer output:** The signal is active from the start until the timer elapses (high active or low active configurable).

**Tolerance band signal timer:** The signal is active if the actual value before the timer start is outside the valid range. If the actual value after the timer starts runs out of the valid range, the timer time is only stopped (timer stop signal active) until the actual values reaches the valid range again! The tolerance band signal is not active in this case.

**End signal timer:** The signal is active after the timer elapses for the duration of the after-run time (or until acknowledgement).

**Stop signal timer:** The signal is active while the timer is stopped.

## Timer symbol (display)

**Off:** Timer is not active (function = off)

**Lights up:** Timer is active (function = on)

**Flashes:** Timer is active and running (symbol also flashes during lead time, if timer has stopped, and during after-run time)





## Behavior after power on

The timer output signals are inactive during the device's initialization phase. The runtime and remaining running time are saved via power off on the device. The behavior after power on is configurable.

## 7.12 Limit value monitoring functions

The device is equipped with four limit value monitoring functions that can be individually configured. The following configuration parameters are available for each of the four limit value monitoring functions.

## 7 Configuration

Parameter	Selection/text/value	Description
Function 	<b>Without function</b>	
	AF1	Limit value above and below the setpoint value
	AF2	As for AF1, output signal inverted
	AF3	Limit value below the setpoint value
	AF4	As for AF3, output signal inverted
	AF5	Limit value above the setpoint value
	AF6	As for AF5, output signal inverted
	AF7	Fixed limit value (independent of the setpoint value)
	AF8	As for AF7, output signal inverted
Actual value input	Analog selector <b>Analog input</b>	Analog signal as actual value (signal to be monitored)
Setpoint value input	Analog selector <b>Current setpoint value</b> (device-dependent)	Analog signal as setpoint value (reference signal for AF1 to AF6)
Limit value	-1999 to 9999 (0)	Admissible deviation (AL) of the actual value
Limit value 2	-1999 to 9999 (0)	For non-standard limit value function: second limit value (AL2) to implement an asymmetrical monitoring band; only for AF1 and AF2  The limit value (AL) is below the setpoint value; the second limit value (AL2) is above the setpoint value.
Switching differential	0 to 9999 (1)	Switching thresholds of the output signal (difference from limit value)
Switching behavior (setup only) 		Switching differential position around the limit value
	<b>Standard</b>	Switching differential is positioned with half above and half below the limit value.
	Non-standard left	Switching differential is below the limit value (typically).
	Non-standard right	Switching differential is above the limit value (typically).
Limit value function (setup only) 		Standard of monitoring band for AF1 and AF2
	<b>Standard</b>	Standard monitoring band, formed by the limit value (AL)
	Non-standard	Non-standard monitoring band, formed by the limit value (AL) and limit value 2 (AL2)
Startup alarm suppression 		Alarm suppression during start-up phase
	<b>Off</b>	Limit value monitoring always operates according to its alarm function.
	On	Alarm suppression after power on or if limit value or setpoint value is changed
Response in case of a fault		Output signal in the event of a fault (e.g., in the event of overrange or underrange)
	<b>Off</b>	Output signal inactive
	On	Output signal active



# 7 Configuration

Parameter	Selection/text/value	Description
Switch-on delay (setup only)	0 to 9999	Delay time (in seconds) for activation of the output signal if alarm condition is present.
Switch-off delay (setup only)	0 to 9999	Delay time (in seconds) for deactivation of the output signal if alarm condition is no longer present.
Pulse time (setup only)	0 to 9999	After this time (in seconds), the output signal is deactivated automatically even if the alarm condition is still present. If the alarm condition occurs again, the function restarts (edge-controlled).
Inhibit signal (setup only)	Digital selector <b>No selection</b>	Signal (high-active) for suppressing the output signal
Self-locking (setup only)	<b>Off</b>	Self-locking is not active. The output signal is reset as soon as the actual value is back in the valid range.
	On	Self-locking is active. Self-locking can only be acknowledged if the actual value is back in the valid range.
	Always acknowledgeable	Self-locking is active. Self-locking can always be acknowledged.
Acknowledgement signal (setup only)	Digital selector <b>No selection</b>	Signal (high-active) for acknowledging the output signal in case of self-locking
Additional functions (setup only)	Expansion 1 to expansion 5	Expansion 1 to 5: Reserved functions for service purposes. Only activate when instructed to do so by service personnel! Click checkbox to activate the function.

## Function

For the AF1 to AF6 alarm functions, the final limit value depends on the setpoint value – the entered limit value is added to or subtracted from the setpoint value. The AF7 and AF8 alarm functions work with a fixed limit value which corresponds to the limit value entered.

⇒ chapter 7.12.1 "Alarm functions and switching behavior", Page 74

## Startup alarm suppression

Function of the startup alarm suppression:

- After power on, the alarm signals for the limit value monitoring function remains inactive, even if the actual value is in the alarm range.
- If the limit value or setpoint value is changed so that the actual value is then within the alarm range, while the actual value is outside of the alarm range, the alarm signal remains inactive.
- The limit value monitoring only starts to operate according to its alarm function again once the actual value has left the alarm range. This means that the alarm signal remains inactive until the actual value returns to the alarm range.

## Behavior after power on

The output signal status is not saved via power off. Limit value monitoring starts after completion of initialization according to its configuration.

# 7 Configuration

## 7.12.1 Alarm functions and switching behavior

This section describes the alarm function AF1 to AF8 and the switching behavior (non-standard left, standard, non-standard right).

### Limit value in relation to the setpoint value

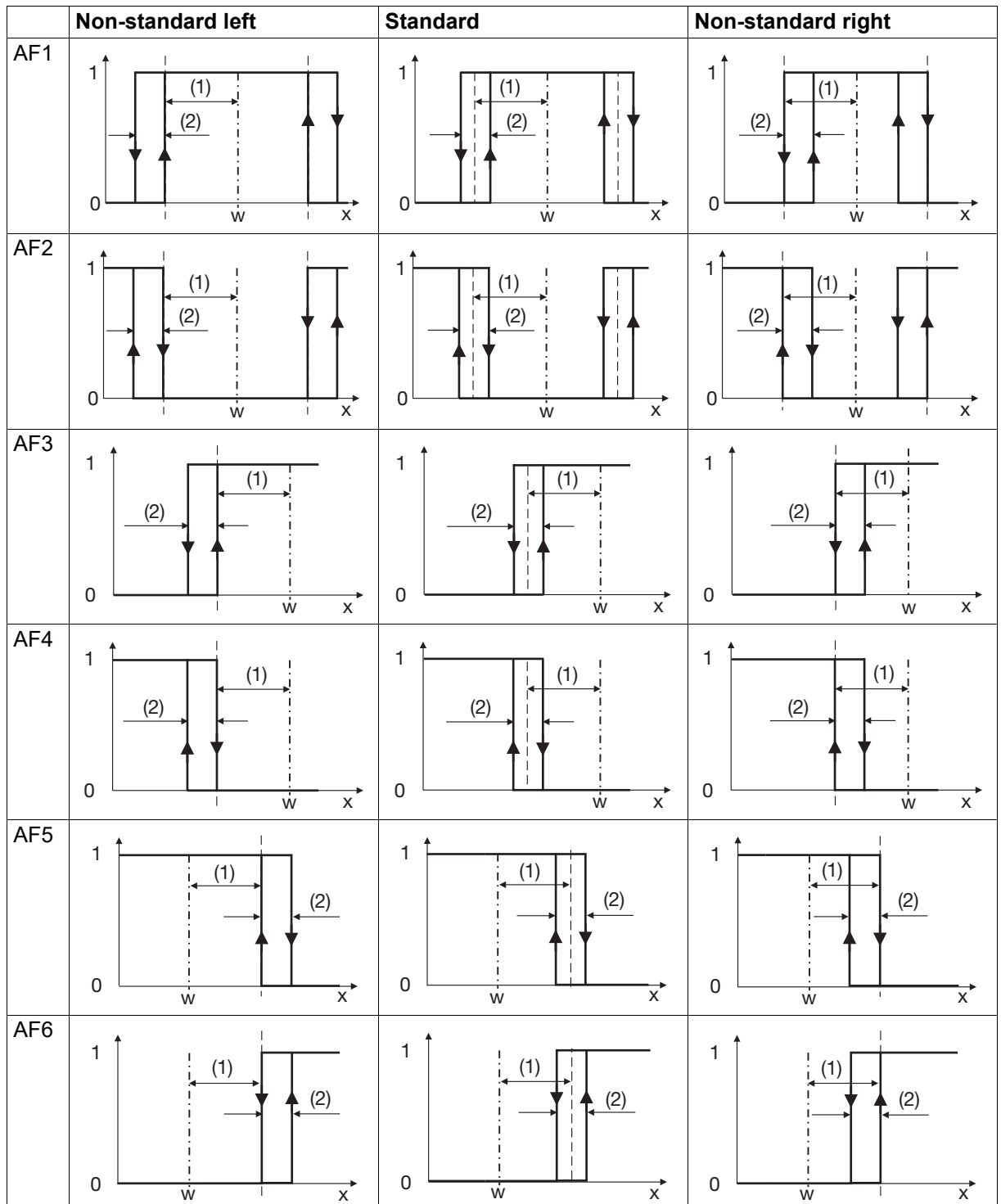

0 = output signal not active

1 = output signal active

x = actual value

w = setpoint value

(1) Limit value (AL)

(2) Switching differential

# 7 Configuration

## Fixed limit value

	Non-standard left	Standard	Non-standard right
AF7			
AF8			

0 = output signal not active

x = actual value

(1) Limit value (AL)

1 = output signal active

(2) Switching differential

## Limit value in relation to the setpoint value – non-standard monitoring band

	Non-standard left	Standard	Non-standard right
AF1			
AF2			

0 = output signal not active

x = actual value

(1) Limit value (AL)

1 = output signal active

w = setpoint value

(2) Switching differential

(3) Limit value 2 (AL2)

# 7 Configuration

---

## 7.13 Serial interface

The device can be optionally equipped with a RS485 interface that is provided for connecting to a Modbus master and is operated as a Modbus slave (Modbus RTU protocol).

Parameter	Selection/text/value	Description
Device address	1 to 254	Modbus device address
Baud rate	<b>9600</b>	9600 baud
	19200	19200 baud
	38400	38400 baud
	115200	115200 baud
Data format	<b>8-1 no parity</b>	8 data bits, 1 stop bit, no parity
	8-1 odd parity	8 data bits, 1 stop bit, odd parity
	8-1 even parity	8 data bits, 1 stop bit, even parity
	8-2 no parity	8 data bits, 2 stop bits, no parity
Min. response time (setup only)	0 to 500 ( <b>40</b> )	The minimum response time (in milliseconds) is adhered to by the device (Modbus slave) before a response is sent following a data request.



### NOTE!

The RS485 interface cannot be operated at the same time as the setup interface (USB).

---



### NOTE!

There is a separate interface description available with further information. Amongst other things, this includes the Modbus addresses of all device data, process value, and configuration parameters available via Modbus.

---

### Behavior after power on

The inputs are set to 0 (binary) or "NOINPUT" (analog) during the device's initialization phase. Once the initialization is complete, the values transferred via Modbus are applied.

## 7.14 Ethernet interface

The device can optionally be equipped with an Ethernet interface which is intended for connection to a Modbus master and is operated as a Modbus slave (Modbus TCP and Modbus RTU/ASCII via TCP/IP protocols).

The settings of the Ethernet interface must be made with the Lantronix CPR Manager PC software from the manufacturer Lantronix, Inc. Configuration on the device or with the setup program is not necessary. Further information can be found in the interface description (Modbus).

The notes listed in the chapter "Serial interface" as well as the behavior after power-on described there also apply to the Ethernet interface.

# 8 Configuration - setup only

The functions described in this chapter can only be configured with the setup program.  
The default settings are shown in bold in the tables.

## 8.1 ST code



### NOTE!

This function is available in the setup program if the "ST code" extra code has been activated (Hardware assistant > Device configuration: ST code). To access this function in the device, it must be enabled with the setup program (CPU: Online parameters > Enabling of extra codes).

The user has the option to create his/her own application using the "Structured text" option (extra code). The application with the ST editor, which is part of the setup program, is created in the PLC programming language "Structured text". The finished application is transmitted to the device and continuously processed there. There is a debugger function available for testing and troubleshooting.

### Variables bool\_in

Parameter	Selection/text/value	Description
bool_in01 to bool_in04	Digital selector <b>No selection</b>	Boolean input variables for the application to be created

### Variables real\_in

Parameter	Selection/text/value	Description
real_in01 to real_in06	Analog selector <b>No selection</b>	Real input variables for the application to be created

### Variables bool\_out

Parameter	Selection/text/value	Description
bool_out01 to bool_out04	<Enter text> STBA01, STBA02, ...	Designation or description of the Boolean output variables for the application to be created

### Variables real\_out

The following configuration parameters are available for each of the six variables.

Parameter	Selection/text/value	Description
Description	<Enter text> STAA01, STAA02, ...	Designation or description of the real output variables for the application to be created
Temperature	<b>None</b>	This selection is important for the automatic conversion in case of a change in temperature unit (°C/°F) (see system data). The value is not a temperature.
	Relative	The value is a temperature difference.
	Absolute	The value is a temperature value.
Unit	<Enter text> %	Value unit (if it is not a temperature)
Scaling start	-99999 to 99999 ( <b>0</b> )	Lower limit of the display range Smaller values are considered invalid (display: ----).

## 8 Configuration - setup only

---

Parameter	Selection/text/value	Description
Scaling end	-99999 to 99999 ( <b>100</b> )	Upper limit of the display range Larger values are considered invalid (display: ----).
Decimal places		Number of pre-decimal and decimal places for the numerical display of the value
	<b>Auto</b>	Automatic
	XXXX.	No decimal place
	XXX.X	One decimal place
	XX.XX	Two decimal places
X.XXX	Three decimal places	

### ST editor

Press the corresponding button to start the ST editor.



#### NOTE!

There is a separate manual for the ST editor available with further information.

---

### Save source code



#### NOTE!

The source code created in the ST editor is transferred into the device in compiled form. It is therefore necessary to save the source code separately in a setup file.

---

## 8.2 Digital control signals

The device provides the option to individually configure up to four digital control signals. The following configuration parameters are available for each of the four control signals.

Parameter	Selection/text/value	Description
Digital signal	Digital selector	Input signal (or OR/AND/XOR signal 1)
	<b>No selection</b>	

## 8 Configuration - setup only

Parameter	Selection/text/value	Description
Function	<b>Without function</b>	The output signal corresponds to the input signal (with inverting if necessary).
	Pulses	A pulse-like signal is output as long as the input signal is active (high).
	Delay	The output signal follows the course of the input signal, whereby the transfer from low to high status and vice versa is delayed.
	Pulse function	On the rising edge of the input signal, the output signal is activated and deactivated after the pulse time has elapsed (even if the input signal is still active). If the edge of the input signal rises again, the function restarts.
	Rising edge	The output signal is activated for the duration of a cycle interval on the rising edge of the input signal.
	Falling edge	The output signal is activated for the duration of a cycle interval on the falling edge of the input signal.
	OR function	Logical OR link of the input signals (signal 1, signal 2, signal 3)
	AND function	Logical AND link
	XOR function	Logical XOR link
Signal 2	Digital selector <b>No selection</b>	Second input signal for the logical link
Signal 3	Digital selector <b>No selection</b>	Third input signal for the logical link
Inversion	<b>No</b>	Output signal (control signal) not inverted
	<b>Yes</b>	Output signal (control signal) inverted
Switch-on time/delay	<b>0</b> to 9999	Pulses: Switch-on time (high status; in seconds) Delay: Delay time (in seconds) for the transition from low to high status
Switch-off time/delay	<b>0</b> to 9999	Pulses: Switch-off time (low status; in seconds) Delay: Delay time (in seconds) for the transition from high to low status
Pulse time	<b>0</b> to 9999	Time (in seconds) for pulse function

### Behavior after power on

The control signals are not active during the device's initialization phase (depending on the configuration).

### 8.3 User level

The individually configurable user level can include up to 16 parameters (process values or configuration parameters).

Select the corresponding line and click "Edit" in order to edit a parameter (or double-click the corresponding line).

## 8 Configuration - setup only

Parameter	Selection/text/value	Description
Parameter	Selector	Select the process value or configuration parameter from the selector  The selected parameter is available in the user level.  Default settings: chapter 4.7 "User level", Page 34
Parameter description in national language 1 to Parameter description in national language 4	<Enter text>	Enter individual text or use default text  The text is used in the user level to name the parameter in the respective national language of the device texts.

### 8.4 Flags

Flags are variables that are available in the device as intermediate storage. They can be edited on the device in the user level or described and read by a Modbus master via interface. The values are not saved on the device (data loss in the event of power failure).

#### Analog flag

The following configuration parameters are available for both of the two analog flags.

Parameter	Selection/text/value	Description
Analog flag	-1999 to 9999 ( <b>0</b> )	Flag value
Temperature		This selection is important for the automatic conversion in case of a change in temperature unit (°C/°F) (see system data).
	<b>None</b>	The value is not a temperature.
	Relative	The value is a temperature difference.
	Absolute	The value is a temperature value.
Unit	<Enter text> %	Value unit (if it is not a temperature)
Decimal places		Decimal places for the numerical display of the value
	Auto	Automatic
	XXXX.	No decimal place
	<b>XXX.X</b>	One decimal place
	XX.XX	Two decimal places
X.XXX	Three decimal places	
Measuring range start	-1999 to 9999 ( <b>0</b> )	Minimum admissible value
Measuring range end	-1999 to 9999 ( <b>100</b> )	Maximum admissible value

#### Digital flag

The following configuration parameter is available for both of the two digital flags.

Parameter	Selection/text/value	Description
Digital flag	<b>Off</b>	"Low" binary value
	On	"High" binary value



## 8.5 Math/Logic



### NOTE!

This function is available in the setup program if the "Math/logic" extra code has been activated (Hardware assistant > Device configuration: Math/logic). To access this function in the device, it must be enabled with the setup program (CPU: Online parameters > Enabling of extra codes).

This optional math and logic function can be used to link analog (math) or binary (logic) values. Four configurable formulae can be created for this.

The following configuration parameters are available for each of the four formulae. Use the "Formula editor" button to open an editor that can be used to create formulae by selecting variables and operators.

Parameter	Selection/text/value	Description
Function	<b>Without function</b>	Function is switched off.
	Math formula	Mathematical link with freely selectable variables and operators
	Logic formula	Logical link with freely selectable variables and operators
Temperature		This selection is important for the automatic conversion in case of a change in temperature unit (°C/°F) (see system data).
	<b>None</b>	The result is not a temperature.
	Relative	The result is a temperature difference.
	Absolute	The result is a temperature value.
Unit	<Enter text> %	Result unit (if it involves a temperature)
Start of display range	-1999 to 9999 ( <b>0</b> )	Lower limit of display range
Display range end	-1999 to 9999 ( <b>100</b> )	Upper limit of display range
Decimal places		Decimal places for the numerical display of the value
	Auto	Automatic
	XXXX.	No decimal place
	<b>XXX.X</b>	One decimal place
	XX.XX	Two decimal places
	X.XXX	Three decimal places
Response in case of a fault		Value of the output signal in the event of a fault (e.g., in case of overrange or underrange)
	<b>Output error value</b>	The math error value 5.0E+37 is output (display: ---).
	Output replacement value	The replacement value is output (see "Replacement value in the event of a fault" parameter).
Replacement value in the event of a fault	-1999 to 9999 ( <b>0</b> )	Replacement value for output in the event of a fault

# 8 Configuration - setup only

Parameter	Selection/text/value	Description
Additional functions	Parameter 1 parameter 2	Parameter 1: Monitoring of the limits of the display range. If the math result is outside of the limits, this is considered as a deviation above or below the measuring range.  Parameter 2: Reserved function for service purposes. Only activate when instructed to do so by service personnel!  Click checkbox to activate the function.



**NOTE!**

The trigonometric functions (SIN, COS, and TAN operators) use degrees (360).

**Behavior after power on**

All calculations are restarted after power on. The output values are set to 0.

## 8.6 Service

A service counter can be implemented with this function. The switch-on duration or the switching frequency of a binary signal is counted here. The service signal is activated once the limit value is reached and remains active until acknowledgement.

In addition, an operating hours counter is available that determines the device's operation duration.

Parameter	Selection/text/value	Description
Service interval	0 to 10000000	Limit value (number or time in hours or days)
Function	<b>Number of switch operations</b>	Counts the switching frequency of a binary signal.
	Time in hours	Counts the switch-on duration of a binary signal in hours.
	Time in days	Counts the switch-on duration of a binary signal in days.
Signal to be monitored	Digital selector <b>No selection</b>	Binary signal whose switching frequency or switch-on duration is counted.
Acknowledgement signal	Digital selector <b>No selection</b>	Binary signal (high active) to acknowledge the service signal
Operating hours counter	<b>Off</b>	Function is switched off The counter is reset to 0.
	Display in hours	Device operating time in hours
	Display in days	Device operating time in days

**Behavior after power on**

Counter readings are maintained after power off (readings are saved on the device in hours).

## 8.7 Ext. analog inputs

External analog inputs are variables that can be described and read by a Modbus master via interface. The values are not saved on the device (data loss in the event of power failure).

The following configuration parameters are available for both of the two external analog inputs.

## 8 Configuration - setup only

Parameter	Selection/text/value	Description
Unit	<Enter text> %	Value unit (if it is not a temperature)
Temperature		This selection is important for the automatic conversion in case of a change in temperature unit (°C/°F) (see system data).
	<b>None</b>	The value is not a temperature.
	Relative	The value is a temperature difference.
	Absolute	The value is a temperature value.
Decimal places		Decimal places for the numerical display of the value
	Auto	Automatic
	XXXX.	No decimal place
	<b>XXX.X</b>	One decimal place
	XX.XX	Two decimal places
	X.XXX	Three decimal places
Start of display range	-1999 to 9999 ( <b>0</b> )	Lower limit of display range
Display range end	-1999 to 9999 ( <b>100</b> )	Upper limit of display range
Reset signal	Digital selector <b>No selection</b>	The reset signal (high active) sets the external analog input to a status of "no input signal".

### 8.8 Ext. digital inputs

External digital inputs are variables that can be described and read by a Modbus master via interface. The values are not saved on the device (data loss in the event of power failure).

The following configuration parameters are available for both of the two external digital inputs.

Parameter	Selection/text/value	Description
Reset signal	Digital selector <b>No selection</b>	The reset signal (high active) sets the external digital input to a binary value of 0.
Signal inversion	<b>No</b>	Input signal not inverted.
	Yes	Input signal inverted.

### 8.9 Customized linearization

The user can create an individual linearization characteristic line for the analog input with the customer-specific linearization. Two procedures are available for this (type of linearization): formula or grid points (value pairs).

The text entered under "designation" is not used at another point in the setup program, but serves merely as text in the sense of a brief description.

#### Formula

Linearization is specified using a formula with five coefficients (4th order polynomial).

Polynomial:  $y = X4 \cdot x^4 + X3 \cdot x^3 + X2 \cdot x^2 + X1 \cdot x + X0$

Parameter	Selection/text/value	Description
Measuring range start	-1999 to 9999 ( <b>0</b> )	Start value of the y axis (linearized value)
Measuring range end	-1999 to 9999 ( <b>100</b> )	End value of the y axis (linearized value)

## 8 Configuration - setup only

---

Parameter	Selection/text/value	Description
X0	-1999 to 9999 (0)	Absolute component of the polynomial (point of intersection with the y axis)
X1	-1999 to 9999 (0)	Coefficient of the linear component (x)
X2	-1999 to 9999 (0)	Coefficient of the quadratic component (x <sup>2</sup> )
X3	-1999 to 9999 (0)	Coefficient of the cubic component (x <sup>3</sup> )
X4	-1999 to 9999 (0)	Coefficient of the quartic component (x <sup>4</sup> )

### "Display graphic" button (displaying linearization on a graphic):

Use this button to create a graphic of the linearization.

The graphic includes the characteristic lines for both types of linearization where applicable, namely the formula and the grid points (table).

The display range for the graphic is initially determined by the "measuring range start" and "measuring range end" values (y values); it can be temporarily changed in the display by entering different x values.

### Grid points

Linearization is specified by entering up to 40 grid points (pairs of values X,Y). The value X stands for the physically measured value (resistance in  $\Omega$  or voltage in mV) for a RTD temperature probe or thermocouple. With the other signal types, the input variable is scaled to 0 to 100% (for voltage/current signal of measuring range, for resistance/potentiometer of resistance Rx, for resistance transmitter of overall resistance). The value Y is the linearized value (e.g., temperature in °C).

Parameter	Selection/text/value	Description
Measured value (X)	-1999 to 9999 (0)	Value of the relevant grid point on the x axis
Linearized value (Y)	-1999 to 9999 (0)	Value of the relevant grid point on the y axis

### button (calculating the polynomial using the grid points):

After entering the value pairs, use this button to calculate a polynomial that describes the progression of the linearization characteristic line.

The calculated coefficients are incorporated into the formula. The characteristic lines for both types of linearization then correspond to each other.

If the x values do not increase in a straight line, the linearization is not applied. In this case, it is impossible to display the graphic or calculate the polynomial.

### "Display graphic" button (displaying linearization on a graphic):

Use this button to create a graphic of the linearization.

The graphic includes the characteristic lines for both types of linearization where applicable, namely the grid points (table) and the formula.

The display range for the graphic is initially determined by the smallest and largest grid points; it can be temporarily changed in the display by entering different x values.

## 9 Online parameter (setup only)

The functions described in this section are only configured or executed in the setup program. An active connection between the setup program and the device is required for this.

The default settings are shown in bold in the tables.

### 9.1 Fine adjustment

You can use this function to correct the measured values of the analog input. In contrast to measured value offsetting, which is used to specify a constant correction value for the entire characteristic line, fine adjustment can also be used to change the gradient of the characteristic line.



The screenshot shows a dialog box titled "Fine adjustment" with a close button (X) in the top right corner. On the left, there is a list box containing "1 Analog input". The main area is titled "1 Analog input" and contains the following settings:

- Fine adjustment: Off (dropdown menu)
- Actual value (low): 0.0000 (text input)
- Setpoint value (low): 0.0000 (text input)
- Actual value (high): 100.00 (text input)
- Setpoint value (high): 100.00 (text input)

At the bottom right, there are "OK" and "Cancel" buttons.

This function is identical to the fine adjustment in the device (Configuration > Analog input > Fine adjustment).

Description of the parameters and the function:

chapter 7.5 "Analog input", Page 50

### 9.2 Approval of extra codes

You can use this function to activate additional functions (extra codes) for the devices via the setup program.

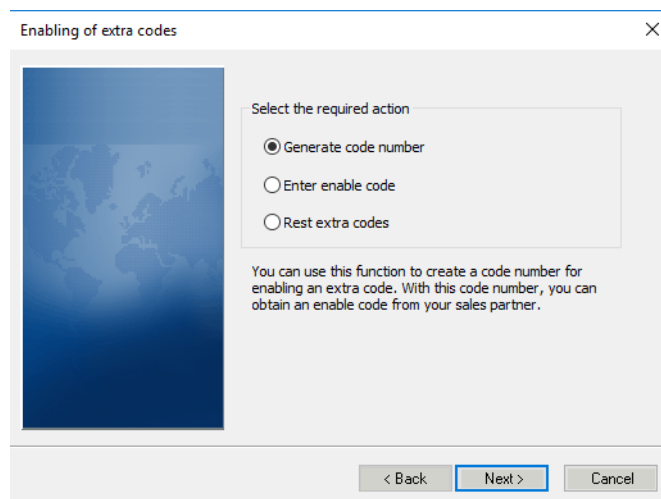

The screenshot shows a dialog box titled "Enabling of extra codes" with a close button (X) in the top right corner. On the left, there is a blue graphic of a world map. The main area contains the following options:

Select the required action

- Generate code number
- Enter enable code
- Rest extra codes

Below the options, there is a text box with the following text:

You can use this function to create a code number for enabling an extra code. With this code number, you can obtain an enable code from your sales partner.

At the bottom, there are "< Back", "Next >", and "Cancel" buttons.

## 9 Online parameter (setup only)

Action	Version	Description
Generate code number	To generate a code number, click the function to select it and then click the "Next" button. Follow the other instructions on the screen.	This function is used to generate a code number to enable an extra code. The code number is required to obtain an activation code from a sales partner.
Enter activation code	To enter an activation code, click the function to select it and then click the "Next" button. Follow the other instructions on the screen.	This function is used to activate an extra code. This requires the activation code received from the sales partner.
Reset extra codes	To reset extra codes, click the function to select it and then click the "Next" button. Follow the other instructions on the screen.	This function can be used to lock an extra code that has been activated. Locked extra codes can only be activated by re-enabling. This procedure is subject to charge.

### 9.3 Calibrate/test

#### Hardware/software

The device's hardware and software status is displayed in this window.

#### Calibration constants

This window displays the calibration constants for the analog input and output.

#### Analog input

This function tests the analog input. To allow this to happen, the signal or resistance must be in place at the analog input.

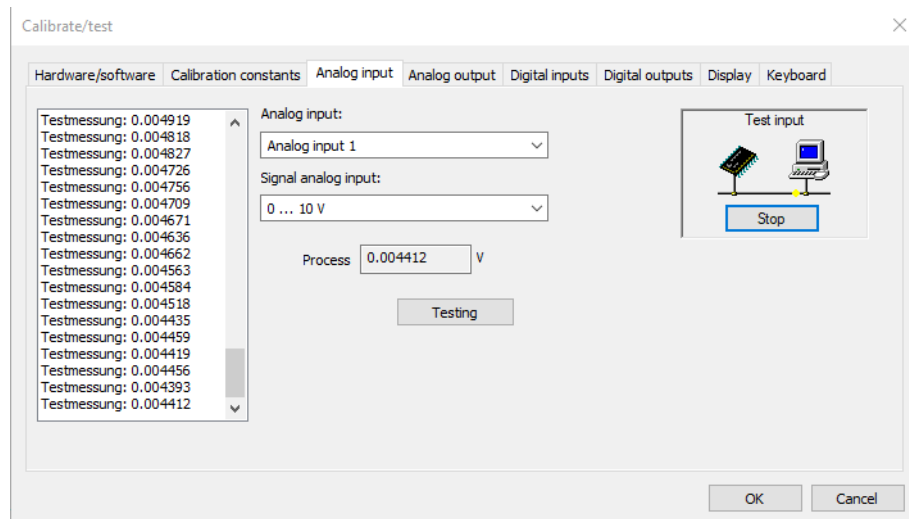

After selecting the corresponding signal type and pressing the "Test" button, the value at the analog input is continuously measured and displayed in the "Act. value" (last value) field as well as in the display field (left; all measured values). The continuous measurement is terminated by pressing "Stop".

#### Analog output

This function tests the analog output. The signal at the analog output must be measured for this purpose.

## 9 Online parameter (setup only)

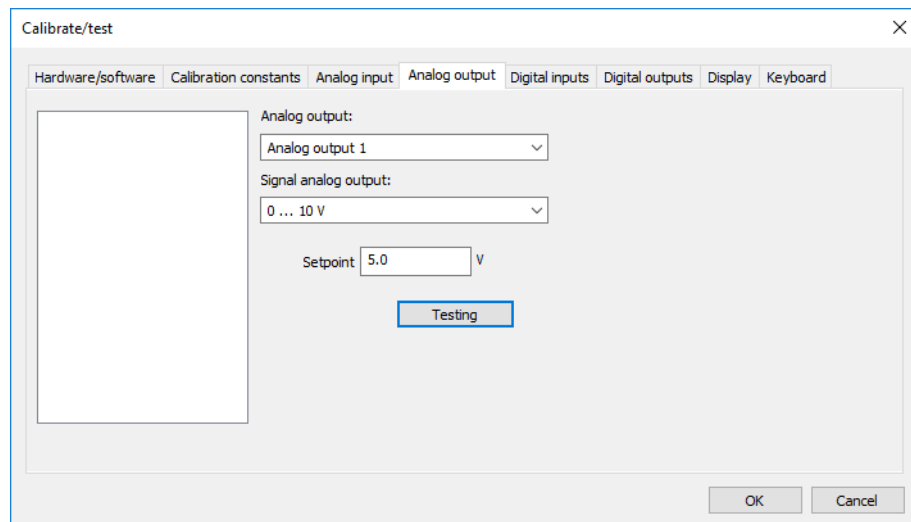

After selecting the corresponding signal type and entering the setpoint value, the corresponding value is output at the analog output by pressing the "Test" button. The output value must be measured and entered in the "Measured value" field. Finally, the setpoint value and actual value (measured value) are displayed for comparison.

### Digital inputs

This function is used to display the logical statuses at the digital inputs. Any inversion activated in the configuration of the respective digital input is not considered.

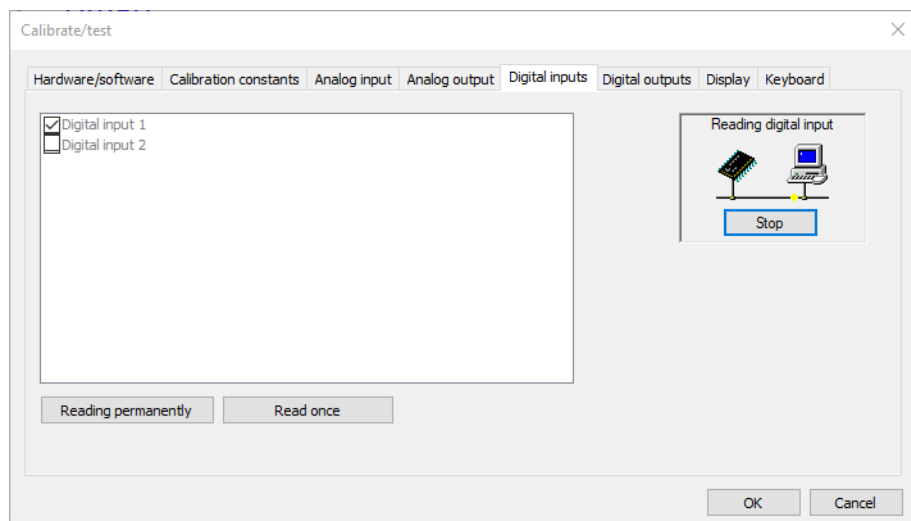

Read permanently: After pressing the button, the inputs are continuously read and the display is continuously updated. Reading must be ended using the "Stop" button.

Read once: The inputs are read once and the determined status is displayed each time the button is pressed.

If the status at an input is TRUE, this is indicated with a check mark in the checkbox.

### Digital outputs

This function is used to set the logical statuses at the digital outputs. Any inversion activated in the configuration of the respective digital output is not considered.

## 9 Online parameter (setup only)

---

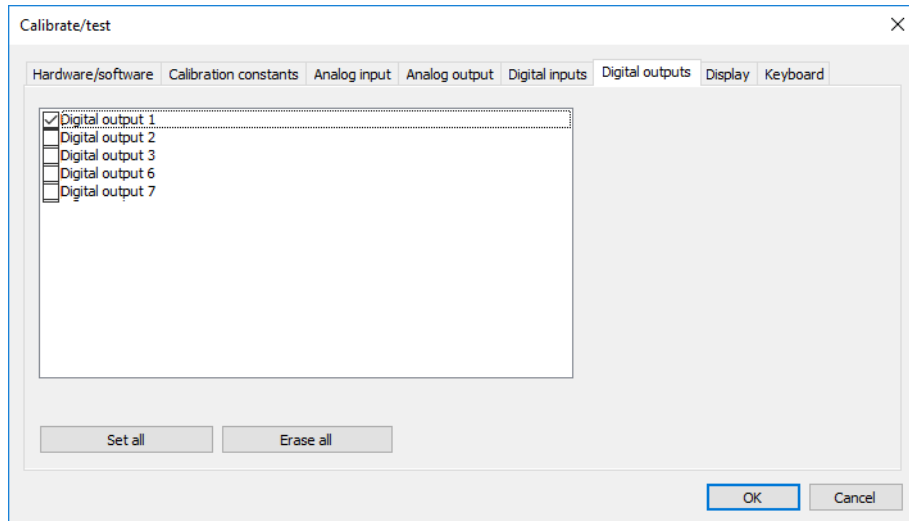

Set all: All outputs are set to TRUE after the button is pressed (checkmark in checkbox).

Delete all: All outputs are set to FALSE after the button is pressed (no checkmark).

Each output can be individually set to TRUE by clicking the checkbox. The output is set back to FALSE by clicking the checkbox again.

### Display

This function is used to activate all display elements of the device.

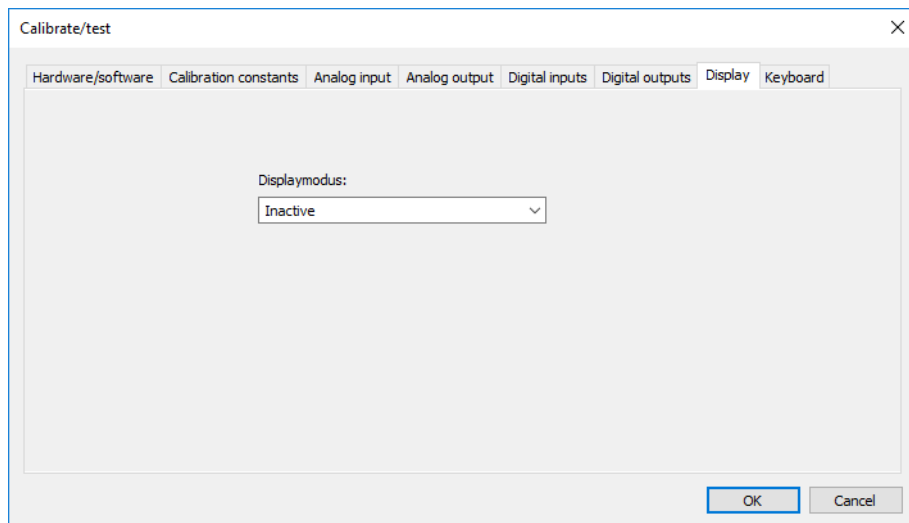

Inactive: The function is not active. The display corresponds to the standard display in calibration/testing mode.

On: All display elements are switched on.

Off: All display elements are switched off.

Toggle: The display changes constantly between the states Off and On.

### Keypad

This function is used to check all device buttons.



## 9 Online parameter (setup only)

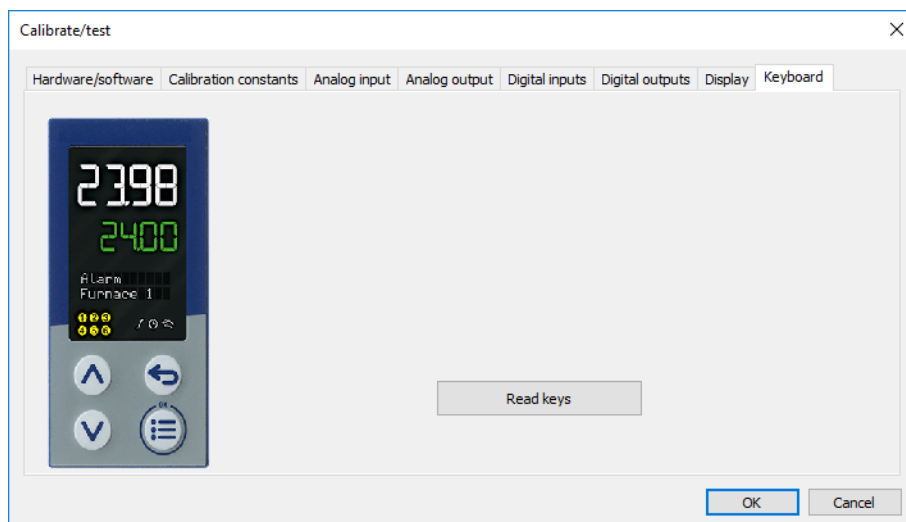

After pressing the "Read buttons", each press of a button on the device is shown by a red circle around the corresponding button of the device shown here:



## 9 Online parameter (setup only)

### 9.4 Additional process values for online data

Additional process values to be displayed in the online data window of the setup program are selected in this window ("Additional process values" tab).

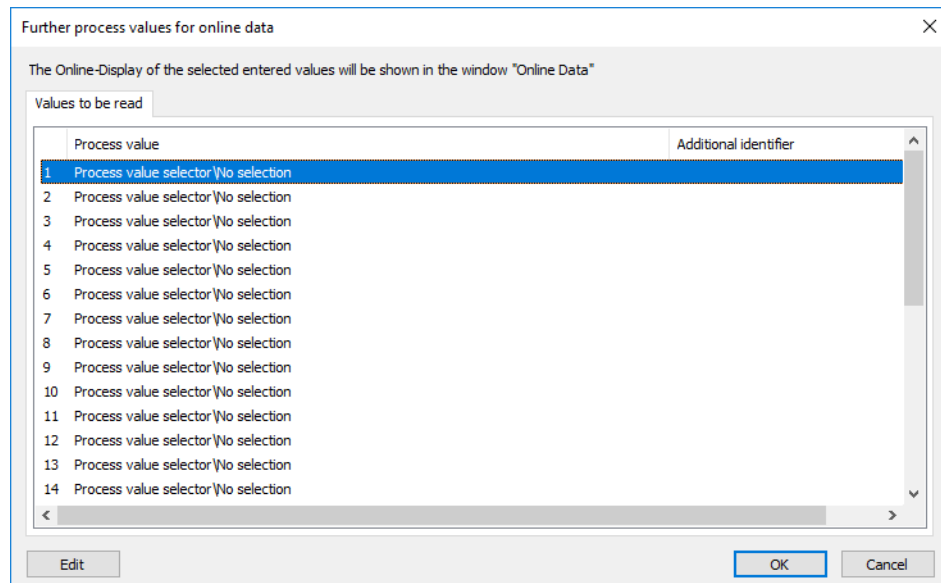

After pressing the "Edit" button (or double clicking on the relevant line), the process value for the previously marked line can be selected:

Parameter	Selection/text/value	Description
Process value	Select the process value from the selector (drop-down menu) <b>No selection</b>	Analog signal, digital signal, or value of a configuration parameter The selection you make is displayed in the online data "Selector" column along with the complete path from the selector. The value of the process value is shown in the "Value" column.
Additional identifier	Enter text (max. 30 characters)	Individual designation of the process value The text is shown in the online data "Identifier" column.
Unit	Enter text (max. 6 characters)	Process value unit The text is shown in the online data "Unit" column.

# 10 Start-up parameter (setup only)

The start-up function, which is a component of the setup program, allows the visualization and recording of process values in real time. This considerably simplifies the startup of a plant.

Amongst other things, there is a print function available in the context menu (right mouse button) that can be used to print out the device configuration.

The default settings are shown in bold in the tables.

## 10.1 Process values

The process values for the visualization, recording, and display in the online data window of the setup program are selected in this window ("Process values for start-up" tab). A distinction is made here between readable and writable values.

### Readable values

Process values can be selected in the "Readable values" tab (analog and digital signals from the selectors and some values from configuration parameters) that are shown both in the visualization (line diagram) and in the online data window.

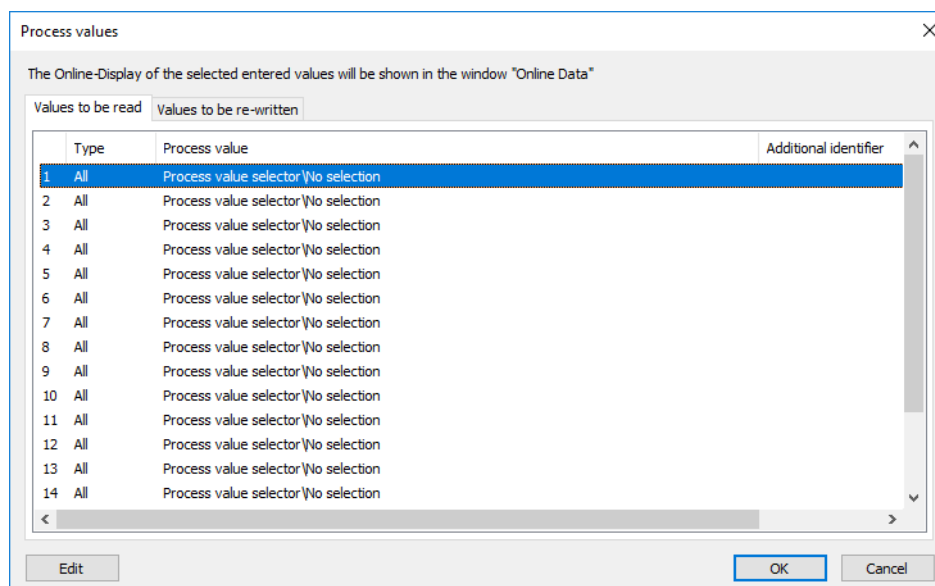

After pressing the "Edit" button (or double clicking on the relevant line), the process value for the previously marked line can be selected:

Parameter	Selection/text/value	Description
Process value	Select the process value from the selector (drop-down menu)  <b>No selection</b>	Analog signal, digital signal, or value of a configuration parameter
Additional identifier	Enter text (max. 30 characters)	Individual designation of the process value The text is used in the visualization and, if applicable, also in the online data window.
Unit	Enter text (max. 6 characters)	Process value unit The text is used in the visualization and, if applicable, also in the online data window.

### Writable values

Process values can be selected in the "Writable values" tab (external analog and digital inputs as well as analog and digital flags) that are only available in the online data window and can be edited there.

# 10 Start-up parameter (setup only)

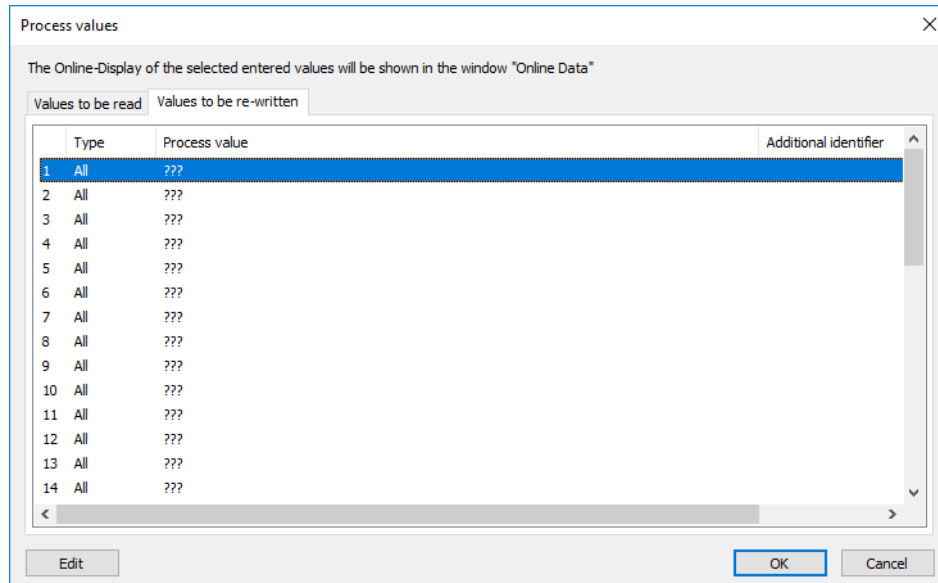

After pressing the "Edit" button (or double clicking on the relevant line), the process value for the previously marked line can be selected:

Parameter	Selection/text/value	Description
Process value	Select the process value from the selector (drop-down menu)  <b>No selection</b>	External analog input, external digital input, analog flag, digital flag, or value of a configuration parameter
Additional identifier	Enter text (max. 30 characters)	Individual designation of the process value The text is used in the online data window.
Unit	Enter text (max. 6 characters)	Process value unit The text is used in the online data window.

## 10.2 Display

The channel properties (color, line type and width, type of y axis, scaling) for the visualization are specified in this window (open by double-clicking).

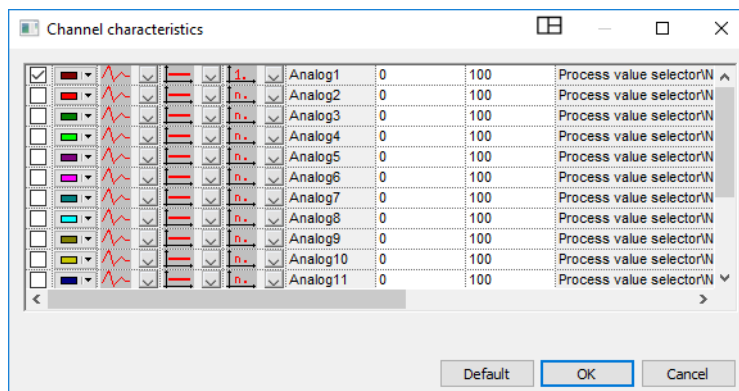

Up to 18 channels in a line chart (channels can be individually hidden) can be shown in the visualization. The X axis depicts the time course of the signals in the diagram. The values of the signals are represented on the Y-axis, whereby only one signal can ever be selected for the main y axis. The values of the other signals are represented either on additional Y axes (auxiliary y axis) or without a y axis.

A toolbar provides various functions for recording, displaying, and archiving process values.

# 10 Start-up parameter (setup only)



The meaning of the symbols is explained by a tool tip function (hover over the respective symbol with the mouse pointer in the setup program).

## Example

The following example shows the recorded curve of the signal at the analog input. The appropriate scaling must be selected for a correct display.

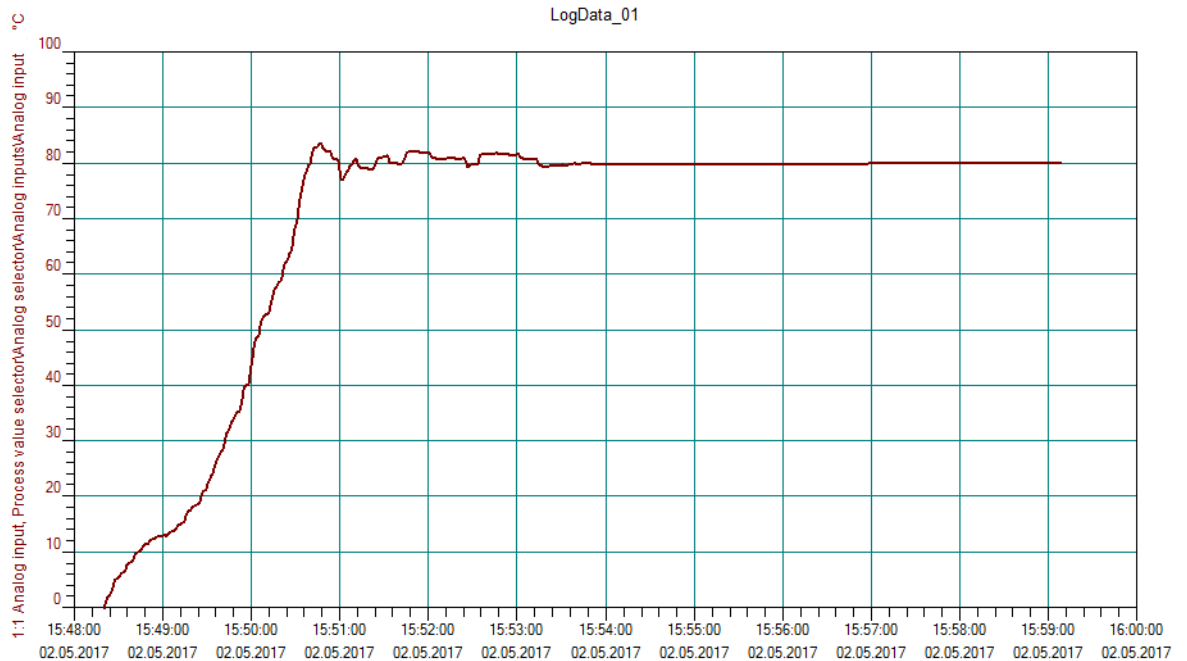

## 10 Start-up parameter (setup only)

---

## 11.1 Analog input

### Thermocouples

Designation	Type	Standard	ITS	Measuring range	Accuracy <sup>a</sup>
Fe-CuNi	"L"	DIN 43710 (1985)	IPTS-68	-200 to +900 °C	≤ 0.25 %
Fe-CuNi	"J"	DIN EN 60584-1:2014 IEC 60584-1:2013	ITS-90	-210 to +1200 °C	≤ 0.25 % from -100 °C
Cu-CuNi	"U"	DIN 43710 (1985)	IPTS-68	-200 to +600 °C	≤ 0.25 % from -100 °C
Cu-CuNi	"T"	DIN EN 60584-1:2014 IEC 60584-1:2013	ITS-90	-270 to +400 °C	≤ 0.25 % from -150 °C
NiCr-Ni	"K"	DIN EN 60584-1:2014 IEC 60584-1:2013	ITS-90	-270 to +1300 °C	≤ 0.25 % from -80 °C
NiCr-CuNi	"E"	DIN EN 60584-1:2014 IEC 60584-1:2013	ITS-90	-270 to +1000 °C	≤ 0.25 % from -80 °C
NiCrSi-NiSi	"N"	DIN EN 60584-1:2014 IEC 60584-1:2013	ITS-90	-270 to +1300 °C	≤ 0.25 % from -80 °C
Pt10Rh-Pt	"S"	DIN EN 60584-1:2014 IEC 60584-1:2013	ITS-90	-50 to +1768 °C	≤ 0.4 % from 20 °C
Pt13Rh-Pt	"R"	DIN EN 60584-1:2014 IEC 60584-1:2013	ITS-90	-50 to +1768 °C	≤ 0.25 % from 50 °C
Pt30Rh-Pt6Rh	"B"	DIN EN 60584-1:2014 IEC 60584-1:2013	ITS-90	-50 to +1820 °C	≤ 0.25 % from 400 °C
W5Re-W26Re	"C"	DIN EN 60584-1:2014 IEC 60584-1:2013	ITS-90	0 to 2315 °C	≤ 0.25 % from 500 °C
W3Re-W25Re	"D"	ASTM E1751M-15	ITS-90	0 to 2315 °C	≤ 0.25 % from 500 °C
W5Re-W20Re	"A1"	GOST R 8.585-2001	ITS-90	0 to 2500 °C	≤ 0.25 % from 500 °C
Chromel®-Copel	"L"	GOST R 8.585-2001	ITS-90	-200 to +800 °C	≤ 0.25 % from -80 °C
Chromel®-Alumel®	"K"	GOST R 8.585-2001	ITS-90	-270 to +1300 °C	≤ 0.25 % from -80 °C

<sup>a</sup> The accuracy value refers to the measuring range.

Ambient temperature influence	≤ 100 ppm/K
Cold junction	Internal or external (constant)
Reference point temperature (external)	0 to 100 °C (adjustable)
Sampling rate	150 ms
Input filter	Digital filter, 2nd order; filter constant can be set from 0 to 100.0 s

### RTD temperature probe

Designation	Standard	ITS	Connection type	Measuring range	Accuracy <sup>a</sup>	Measuring current
Pt100	DIN EN 60751:2009 IEC 60751:2008	ITS-90	Two-wire	-200 to +850 °C	≤ 0.2 %	500 µA
			Three-wire	-200 to +850 °C	≤ 0.1 %	500 µA
Pt1000	DIN EN 60751:2009 IEC 60751:2008	ITS-90	Two/three-wire	-200 to +850 °C	≤ 0.1 %	50 µA
Pt100	GOST 6651-2009 A.2	ITS-90	Two-wire	-200 to +850 °C	≤ 0.2 %	500 µA
			Three-wire	-200 to +850 °C	≤ 0.1 %	500 µA
KTY			Two-wire	-53 to +153 °C	≤ 2.0 %	50 µA

# 11 Technical data

<sup>a</sup> The accuracy value refers to the measuring range.

Ambient temperature influence	≤ 50 ppm/K
Sensor line resistance	Max. 30 Ω per line
Sampling rate	150 ms
Input filter	Digital filter, 2nd order; filter constant can be set from 0 to 100.0 s

## Resistance transmitter and resistor/potentiometer

Designation	Measuring range	Accuracy <sup>a</sup>	Measuring current
Resistance transmitter	0 to 4000 Ω	≤ 0.1 %	50 μA
Resistance/potentiometer	0 to 400 Ω	≤ 0.1 %	500 μA
	0 to 4000 Ω	≤ 0.1 %	50 μA

<sup>a</sup> The accuracy value refers to the maximum measuring range. Small measuring spans lead to reduced linearization accuracy.

Ambient temperature influence	≤ 100 ppm/K
Connection type	
Resistance transmitter	Three-wire circuit
Resistance/potentiometer	Two-wire/three-wire circuit
Sensor line resistance	Max. 30 Ω per line
Sampling rate	150 ms
Input filter	Digital filter, 2nd order; filter constant can be set from 0 to 100.0 s

## Voltage, current (standard signals)

Designation	Measuring range	Accuracy <sup>a</sup>	Input resistance or burden voltage
Voltage	0 to 10 V	≤ 0.1 %	> 500 kΩ
	2 to 10 V	≤ 0.1 %	> 500 kΩ
Current	4 to 20 mA	≤ 0.1 %	< 2.5 V
	0 to 20 mA	≤ 0.1 %	< 2.5 V

<sup>a</sup> The accuracy value refers to the maximum measuring range. Small measuring spans lead to reduced linearization accuracy.

Ambient temperature influence	≤ 100 ppm/K
Deviation below/above the measuring range	According to NAMUR recommendation NE 43 (only current input 4 to 20 mA)
Sampling rate	150 ms
Input filter	Digital filter, 2nd order; filter constant can be set from 0 to 100.0 s

## Measuring circuit monitoring

The device behavior in the event of a fault is configurable.

Measuring probe	Measuring range underflow	Measuring range overflow	Short-circuit (probe/line)	Break (probe/line)	Polarity
RTD temperature probe	++	++	++	++	---
Resistance/potentiometer	---	++	---	++	---
Resistance transmitter	---	++	(+) <sup>a</sup>	(+) <sup>b</sup>	---
Thermocouple	++	++	---	++	(+) <sup>c</sup>



# 11 Technical data

Measuring probe	Measuring range underflow	Measuring range overflow	Short-circuit (probe/line)	Break (probe/line)	Polarity
Current 0 to 20 mA	---	++	---	---	---
Current 4 to 20 mA	++	++	++	++	++
Voltage 0 to 10 V	---	++	---	---	++
Voltage 2 to 10 V	++	++	++	++	++
++ = is detected		--- = is not detected		(+) = is detected in certain conditions	

<sup>a</sup> Is not detected in all combinations

<sup>b</sup> Break in measuring current path is not detected

<sup>c</sup> Dependent on the set characteristic line

## 11.2 Digital inputs

Input for potential-free contact	
Function	Contact closed: input is active ( $R_{ON} < 1 \text{ k}\Omega$ ) Contact open: input is inactive ( $R_{OFF} > 50 \text{ k}\Omega$ )
Sampling rate	150 ms

## 11.3 Analog output

Voltage	
Output signal	DC 0(2) to 10 V
Load resistance	$> 500 \Omega$
Current	
Output signal	DC 0(4) to 20 mA
Load resistance	$< 450 \Omega$
Accuracy	$\leq 0.5 \%$
Ambient temperature influence	$\leq 150 \text{ ppm/K}$

# 11 Technical data

## 11.4 Digital outputs

Relay (N/O contact) Switching capacity Contact life	Max. 3 A at AC 230 V or DC 30 V, resistive load 150,000 operations at rated load 350,000 operations at 1 A
Relay (N/O contact) with longer contact life Switching capacity Contact life	Max. 3 A at AC 230 V, resistive load 300,000 operations at rated load 1,500,000 operations at 1 A
Logic output Output signal Current Switching time when used as a controller output	DC 0/14 V $\pm$ 15 % Max. 20 mA per output (at nominal voltage 14 V) Min. 10 ms
PhotoMOS <sup>®</sup> relay <sup>a</sup> Switching capacity	Max. 200 mA at AC 30 V or DC 45 V; not short-circuit proof

<sup>a</sup> PhotoMOS is a registered trademark of Panasonic Corporation.

## 11.5 Interfaces

USB device Connector type Standard Max. cable length	Micro-B (socket) Low-Speed, Full-Speed 5 m
RS485 Baud rate Data format Protocol	9600, 19200, 38400, 115200 8/1n, 8/1e, 8/1o, 8/2n Modbus-RTU as slave
Ethernet Connector type Transfer rate Protocol	RJ45 (socket) 10 Mbit/s, 100 Mbit/s TCP/IP, DHCP; Modbus-TCP, Modbus-RTU/ASCII via TCP, as slave

## 11.6 Display

18-segment LCD displays		
Digit height	Upper display:	Lower display:
Type 702110 (format 132)	7.2 mm	3.8 mm
Type 702111 (format 116)	12.3 mm	5.9 mm
Type 702112 (format 108H)	11.5 mm	8.5 mm
Type 702113 (format 108Q)	16.5 mm	9 mm
Type 702114 (format 104)	24.8 mm	12 mm
Color	Upper display: white; lower display: green	
Places, including decimal places	Upper display: 4; lower display: 4 (5 for type 702110, 8 for type 702111)	
Decimal places	0, 1, 2, 3 or automatic (configurable)	

Pixel matrix LCD display (only for types 702112, 702113, and 702114)	
Pixel fields	
Type 702112 (format 108H)	2 rows each with 9 pixel fields
Type 702113 (format 108Q)	2 rows each with 8 pixel fields
Type 702114 (format 104)	2 rows each with 11 pixel fields
Number of pixels per field	8 x 5
Color	White

## 11.7 Electrical data

Voltage supply	(see nameplate)	
Variant 1	AC 110 to 240 V +10/-15 %, 48 to 63 Hz	
Variant 2	AC/DC 20 to 30V, 48 to 63Hz	
Electrical safety	According to EN 61010, part 1; overvoltage category II to 300 V mains voltage, pollution degree 2	
Protection rating	I with internal isolation from SELV	
Power consumption	For AC 110 to 240 V:	For AC/DC 20 to 30 V:
Type 702110 (format 132)	Max. 3.5 W	Max. 3.0 W
Type 702111 (format 116)	Max. 4.1 W	Max. 3.7 W
Types 702112, 702113 (formats 108H, 108Q)	Max. 5.8 W	Max. 5.7 W
Type 702114 (format 104)	Max. 6.6 W	Max. 6.7 W
Electrical connection	On the back via spring-cage terminals (Push-In technology)	
Conductor cross section	Min. 0.2 mm <sup>2</sup> , max. 1.5 mm <sup>2</sup>	
Wire or stranded wire (without ferrule)	Min. 0.2 mm <sup>2</sup> , max. 1.5 mm <sup>2</sup>	
Stranded wire with ferrule	Without plastic collar: min. 0.2 mm <sup>2</sup> , max. 1.5 mm <sup>2</sup> With plastic collar: min. 0.2 mm <sup>2</sup> , max. 0.75 mm <sup>2</sup>	
Stripping length	8 mm	

## 11.8 Environmental influences

Ambient temperature range	
Storage	-30 to +70 °C
Operation	-10 to +55 °C
Site altitude	Max. 2000 m above sea level
Climatic environmental influences	According to DIN EN 60721-3 with extended temperature range
Resistance to climatic conditions	≤ 90 % rel. humidity without condensation
Storage	According to class 1K2
Operation	According to class 3K3
Mechanical environmental influences	According to DIN EN 60721-3
Storage	According to class 1M2
Transport	According to class 2M2
Operation	According to class 3M3

# 11 Technical data

Electromagnetic compatibility (EMC)	According to DIN EN 61326-1
Interference emission	Class A – only for industrial use –
Interference immunity	Industrial requirements

## 11.9 Case

Case type	Plastic housing for panel mounting according to DIN IEC 61554 (indoor use)
Case front	Made of plastic with membrane keyboard
Panel thickness	1 to 10 mm
Case fastening	In panel using the supplied mounting frame or both mounting elements
Operating position	Any <sup>a</sup>
Protection type	According to DIN EN 60529, IP65 on the front, IP20 on the back
Weight	
Type 702110 (format 132)	Max. 85 g
Type 702111 (format 116)	Max. 120 g
Type 702112 (format 108H)	Max. 160 g
Type 702113 (format 108Q)	Max. 160 g
Type 702114 (format 104)	Max. 220 g

<sup>a</sup> The maximum admissible ambient temperature only applies for the installation with the display in a vertical position.

## 11.10 Approvals and approval marks

Approval mark	Test facility	Certificate/certification numbers	Inspection basis	Valid for
c UL us	Underwriters Laboratories	E201387	UL 61010-1 (3. Ed.), CAN/CSA-22.2 No. 61010-1 (3. Ed.)	All types
DNV GL	DNV GL	TAA00001B3	Class Guideline DNVGL-CG-0339	Type 702111 (DC 20 to 30 V) and type 702114 (AC 110 to 240 V), without Ethernet interface, panel mounting
BUREAU VERITAS	Bureau Veritas	53627/A0 BV	Bureau Veritas Rules for the Classification of Steel Ships	

The device is approved if the relevant approval mark is shown on the device.

	<p><b>产品中有害物质的名称及含量</b> China EEP Hazardous Substances Information</p>						
<p>产品组别 Product group: 702110, 702111, 702112, 702113, 702114</p>							
<p>部件名称 Component Name</p>	<p>铅 (Pb)</p>	<p>汞 (Hg)</p>	<p>镉 (Cd)</p>	<p>六价铬 (Cr(VI))</p>	<p>多溴联苯 (PBB)</p>	<p>多溴二苯醚 (PBDE)</p>	
<p>外壳 Housing (Gehäuse)</p>	○	○	○	○	○	○	
<p>过程连接 Process connection (Prozessanschluss)</p>	○	○	○	○	○	○	
<p>螺母 Nuts (Mutter)</p>	○	○	○	○	○	○	
<p>螺栓 Screw (Schraube)</p>	○	○	○	○	○	○	
<p>本表格依据SJ/T 11364的规定编制。 This table is prepared in accordance with the provisions SJ/T 11364. ○：表示该有害物质在该部件所有均质材料中的含量均在GB/T 26572规定的限量要求以下。 Indicate the hazardous substances in all homogeneous materials' for the part is below the limit of the GB/T 26572. x：表示该有害物质至少在该部件的某一均质材料中的含量超出GB/T 26572规定的限量要求。 Indicate the hazardous substances in at least one homogeneous materials' of the part is exceeded the limit of the GB/T 26572.</p>							







**JUMO GmbH & Co. KG**

Street address:  
Moritz-Juchheim-Straße 1  
36039 Fulda, Germany

Delivery address:  
Mackenrodtstraße 14  
36039 Fulda, Germany

Postal address:  
36035 Fulda, Germany

Phone: +49 661 6003-0  
Fax: +49 661 6003-607  
Email: [mail@jumo.net](mailto:mail@jumo.net)  
Internet: [www.jumo.net](http://www.jumo.net)

**JUMO Instrument Co. Ltd.**

JUMO House  
Temple Bank, Riverway  
Harlow, Essex, CM20 2DY, UK

Phone: +44 1279 63 55 33  
Fax: +44 1279 62 50 29  
Email: [sales@jumo.co.uk](mailto:sales@jumo.co.uk)  
Internet: [www.jumo.co.uk](http://www.jumo.co.uk)

**JUMO Process Control, Inc.**

6724 Joy Road  
East Syracuse, NY 13057, USA

Phone: +1 315 437 5866  
Fax: +1 315 437 5860  
Email: [info.us@jumo.net](mailto:info.us@jumo.net)  
Internet: [www.jumousa.com](http://www.jumousa.com)

