

JUMO safetyM STB/STW

Safety temperature limiter,
safety temperature monitor
according to DIN EN 14597

UKFAHL



c PA US



Type 701150/8-01-0253-2001-23/005, 058

Operating Manual
(translation of the German
original manual)

70115000T90Z004K000

JUMO

V5.00/EN /00564764/2023-06-31

Operating overview

Normal display (approx. 5 secs after switch-on)

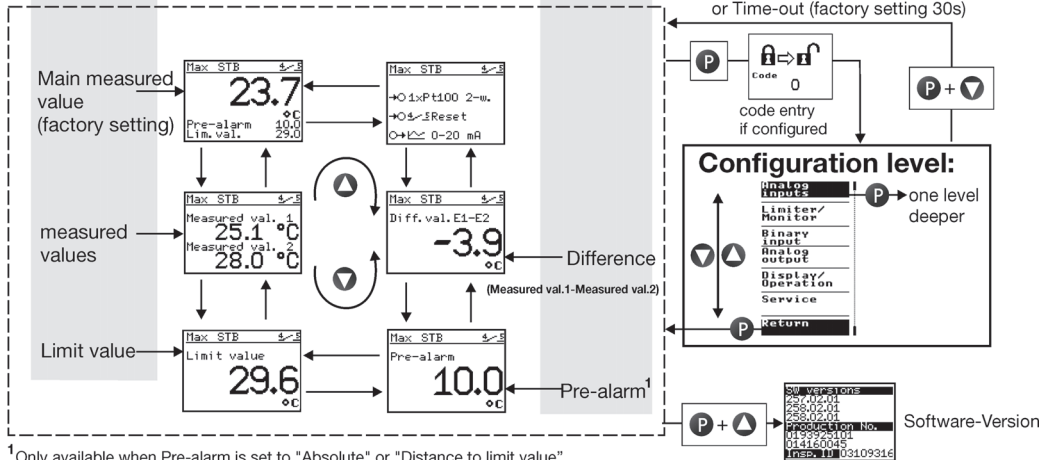

¹Only available when Pre-alarm is set to "Absolute" or "Distance to limit value"

Operating overview	2
1 Brief description	10
1.1 Safety temperature monitor (STW)	10
1.2 Safety temperature limiter (STB)	10
1.3 Safety information	11
1.4 Safety	11
2 Identifying the device version	12
2.1 Changing of the factory set switching behavior	13
2.2 Scope of delivery	15
2.3 Device software versions	16
2.4 Serial number	16
2.5 Service addresses	16
2.6 Approvals	17
3 Installation	20
3.1 Dimensions	20
3.2 Installation location, DIN rail installation	21
3.3 Close mounting	21
3.4 Dismantling	22
3.5 Electrical isolation	23
3.6 Use of the setup interface	23
4 Electrical connection	24
4.1 Installation notes	24
4.2 Connection diagram	26

Content

5	Commissioning the device	31
5.1	Display and operating elements	31
5.2	Setting the display after switch-on	31
5.3	Selecting and editing parameters (plausibility inquiry for input values)	33
5.4	Aborting edit	34
5.5	Alarm acknowledgement using the Reset key (only for temperature limiters STB)	34
5.6	Alarm acknowledgement via binary input (only for temperature limiters STB)	34
5.7	Lead sealing the device	35
6	Safety Manual	36
6.1	Brief description	36
6.2	Safety temperature monitor (STW)	36
6.2.1	Safe operating status STW	36
6.3	Safety temperature limiter (STB)	37
6.3.1	Safe operating status STB	37
6.4	Relevant standards	37
6.5	Validity of the Safety Manual	38
6.6	Connection possibilities of the sensors (SIL)	38
6.6.1	Achievable SIL	39
6.7	Standards and definitions	41
6.7.1	Terms and abbreviations acc. to DIN EN 14597	41
6.7.2	Terms and abbreviations acc. to DIN EN 61 508 and DIN EN 61 511	42
6.8	Safety instrumented parameters related to the temperature monitoring unit	45
6.8.1	Failure rates and SFF for 701150...23 (AC 230 V)	45
6.8.2	Failure rates and SFF for 701150...25 (AC/DC 24 V)	46

6.9	Determining the Safety Integrity Level (SIL)	47
6.9.1	Safety integrity of the hardware	49
6.9.2	Safety-relevant system properties	50
6.10	Determining the achieved Performance Level PL	52
6.10.1	Terms and abbreviations acc. to DIN EN ISO 13849	52
6.11	Connection possibilities of the sensors (PL)	55
6.11.1	Calculations DIN EN ISO 13849-1 Performance Level - low voltage 230 V	57
6.11.2	Calculations DIN EN ISO 13849-1 Performance Level - extra low voltage (ELV) 24 V	57
6.11.3	Contribution to risk minimization through the control system	58
6.12	Evaluating the achieved Performance Level PL and the relationship to the SIL	60
6.13	Other applicable device documentation	63
6.14	Behavior during operation and in case of malfunction	63
6.15	Regular tests	63
6.15.1	Recommended tests for temperature probes	63
7	Configuration level	66
7.1	Navigation principle	66
7.2	Analog inputs	67
7.2.1	Connection	67
7.2.2	Sensor type 1	68
7.2.3	Offset 1	69
7.2.4	Lead wire resistance 1 (resistivity)	69
7.2.5	Filter time 1	70
7.2.6	Scaling start 1	70
7.2.7	Scaling end 1	70

Content

7.2.8	Sensor type 2	71
7.2.9	Offset 2	72
7.2.10	Lead wire resistance 2 (resistivity)	72
7.2.11	Filter time 2	73
7.2.12	Scaling start 2	73
7.2.13	Scaling end 2	73
7.3	Limiters/monitor	74
7.3.1	Device function	74
7.3.2	Switching behavior	75
7.3.3	Limit value, hysteresis	77
7.3.4	Pre-alarm function	77
7.3.5	Pre-alarm, hysteresis	85
7.3.6	Error Pre-alarm, Relay pre-alarm	85
7.3.7	Limit value difference, hysteresis	85
7.3.8	Setting range min. (formerly ALHI)	86
7.3.9	Setting range max. (formerly ALLO)	86
7.4	Binary input	87
7.4.1	Function	87
7.5	Analog output	88
7.5.1	Function	88
7.5.2	Signal type	88
7.5.3	Scaling start	88
7.5.4	Scaling end	88
7.5.5	Error cases	89
7.5.6	Error signal	89

7.5.7	Behavior when leaving the scaling range	.90
7.6	Display/operation	.91
7.6.1	Language	.91
7.6.2	Unit	.91
7.6.3	Decimal place	.91
7.6.4	Normal display	.91
7.6.5	Contrast	.92
7.6.6	Lighting	.92
7.6.7	Time-out light	.92
7.6.8	Time-out operation	.92
7.6.9	Code	.92
7.7	Service	.93
7.7.1	Limit switching cycle	.93
7.7.2	Current switching cycles	.93
7.7.3	Operating hours	.93
8	Technical data	.94
8.1	Analog inputs	.94
8.2	Analog output	.97
8.3	Binary input	.97
8.4	Relay outputs	.97
8.5	Measuring circuit monitoring	.98
8.6	Voltage supply	.98
8.7	Test voltages according to EN 60730, part 1	.99
8.8	Electrical safety	.99

Content

8.9	Environmental influences	99
8.10	Case	100
8.11	Note for suitable probes	100
8.12	Probes for the operating medium air	101
8.13	Probes for water and oil	102
8.14	Probes for water, oil and air	105
9	Setup program	106
9.1	Minimum hardware and software prerequisites:	106
9.2	Displaying the device software version	106
9.3	Forgotten the code?	107
9.4	Special function: thermocouple reverse polarity protection.	107
10	Alarm messages	108
11	Error messages	109
12	What to do, if ...	114
13	Information for devices with extra code 062 GL	116
13.1	Technical data	116
13.2	Alarm messages	116
13.3	Locks	116
14	Output behavior	118
15	SIL and PL	124
16	China RoHS	126

1 Brief description

The safety temperature limiter (**STB**) and the safety temperature monitor (**STW**) are used to reliably detect and avert hazards that could cause injuries, are harmful to the environment or cause destruction of production plants and produced goods, at an early stage.

Its primary task is to reliably monitor thermal processes and switch the systems to an operationally safe status in the event of malfunctions.

The measured value at the analog input can be recorded by various probes or standard signals.

The limit value overrange is indicated by the installed LEDs K1 and K2 (red) for each channel, and the installed relay "Alarm" switches the system to an operationally safe status (**alarm range**).

The high standards of DIN EN 61 508 and DIN EN ISO 13849 are met by a device design, the 1oo2D structure of which ensures reliable detection of errors and, thus, can also be used for applications according to the new Machinery Directive 2006/42/EC.

1.1 Safety temperature monitor (STW)

The STW is a safety component according to Machinery Directive, which, when activated, resets automatically if the probe temperature has gone below / exceeded the limit value by an amount equal to the hysteresis. Possible settings: monitoring for limit value overrange or underrange.

⇒ Chapter 7.3.2 "Switching behavior"

1.2 Safety temperature limiter (STB)





The STB is a safety component according to Machinery Directive that is permanently locked after response. Manual reset using the ● (RESET) key is only possible once the probe temperature has gone below / exceeded the limit value by an amount equal to the hysteresis. Possible settings: monitoring for limit value overrange or underrange.

⇒ Chapter 7.3.2 "Switching behavior"

The transparent cover can be lead sealed to prevent unauthorized operation.

However, the ● (RESET) key remains accessible.

1.3 Safety information

Symbol	Meaning	Explanation
	Note	This symbol is used to draw your attention to important information .
	Caution	This symbol is used when there is a risk of damage to equipment or data if the instructions are ignored or not followed correctly.
	Danger	This symbol is used when there is a risk of injury to persons if the instructions are ignored or not followed correctly.
	Read	This text contains important information and must always be read before work is continued. Handling the device in any way that is not described in the Operating Manual or that is expressly forbidden will jeopardize your warranty rights.
	Reference	This symbol refers to further information in other manuals, chapters or sections.
abc ¹	Footnote	Footnotes are remarks referring to specific points in the text marked with a superscript number.
*	Instructions for action	This symbol indicates that an action to be performed is described. The individual steps are marked by an asterisk.

1.4 Safety

In the sense of "Network and system security" according to the series of standards IEC 62443 no steps inside the device have been taken .

This means, that only the aspects of "safety" are determined in the series of JUMO STB/STW.

2 Identifying the device version

Exemplary illustration of the type plate which is attached to the side of the device.

JUMO GmbH & Co. KG 36039 Fulda,
www.jumo.net

JUMO safetyM STB/STW

Typ: 701150/8-01-0253-2001-23/005, 058

STB "O" SW: 257.02.02/258.02.01

⊕ 2x Pt100 dl

⊕ 3A, 230VAC - ohm. Last

~ AC 110...240V, +10/-15%, 48...63Hz, 12VA



STB/STW1223

F-Nr: 0505039101023180005

TN: 30048731



Voltage supply AC 110 to 240 V:

JUMO GmbH & Co. KG 36039 Fulda,
www.jumo.net

JUMO safetyM STB/STW

Typ: 701150/8-01-0253-2001-25/005

STB "O" SW: 123.12.1*

⊕ 2x Pt100 dl

⊕ 3A, 230VAC - ohm. Last

~ AC/DC 20...30V, 48...63Hz, 12VA



STB/STW1223

F-Nr: 0000000001001010000

TN: 00548737



Switching behavior

Voltage supply AC/DC20 to 30 V:



The voltage supply must correspond to the voltage given on the type plate!

2.1 Changing of the factory set switching behavior

If the safety function according to EN 14597 is changed to Max-Alarm then that change should be corrected on the nameplate.

Example:

This change can be noted directly underneath the nameplate using a waterproof marker.

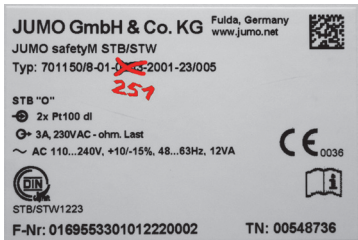

701150

Basic type

Safety temperature limiters (STB) / monitors (STW) according to DIN EN 14597

Version

Factory setting

Configured according to customer specifications

Language

German (factory setting)

English

French

Switching behavior

0251 Safety temperature monitor max. alarm (inverse, N/C contact)

0252 Safety temperature monitor min. alarm (direct, N/O contact)

0253 Safety temperature limiter max. alarm (inverse, N/C contact)

0254 Safety temperature limiter min. alarm (direct, N/O contact)

Measuring input¹ (programmable)

1003 1x Pt100 in 2-wire circuit

2001 2x Pt100 in 3-wire circuit (ex-factory)

2003 2x Pt100 in 2-wire circuit

2006 2x Pt1000 in 3-wire circuit

2036 2x W5Re-W26Re „C“

2037 2x W3Re-W25Re "D"

2039 2x Cu-CuNi "T"

2040 2x Fe-CuNi "J"

2041 2x Cu-CuNi "U"

2042 2x Fe-CuNi "L"

8

9

01

02

03

0251

0252

0253

0254

1003

2001

2003

2006

2036

2037

2039

2040

2041

2042

		2043	2x NiCr-Ni "K"
		2044	2x Pt10Rh-Pt "S"
		2045	2x Pt13Rh-Pt "R"
		2046	2x Pt30Rh-Pt6Rh "B"
		2048	2x NiCrSi-NiSi "N"
		1053	1x 4 to 20 mA
		2053	2x 4 to 20 mA
<hr/>			
			Voltage supply
	23		AC 110 to 240 V +10 % /-15 %, 48 to 63 Hz
	25		20 to 30 V AC/DC, 48 to 63 Hz
<hr/>			
			Analog output (configurable)
		001	0 to 20 mA
		005	4 to 20 mA (ex-factory)
		040	0 to 10 V
		070	2 to 10 V
<hr/>			
			Extra code
		058	SIL and PL approval (membrane keypad yellow)
		062	DNV approval
701150 /	8 -	01 -	0253 -
		2001 -	23 /
			005 ,
			062

1. The first number on the measuring input means single probe "1" or double probe "2"

2.2 Scope of delivery

- JUMO safetyM STB/STW in the version ordered
- Operating Manual

2.3 Device software versions

Diagnosis module version: 257.02.02

Analog channel 1 version: 258.02.01

Analog channel 2 version: 258.02.01



```
SW versions  
257.02.01  
258.02.01  
258.02.01  
Production No.  
0193925101  
014160045  
Insp. ID 03109316
```

2.4 Serial number

The serial number is indicated on the device.

* Press the **P** + **▲** keys

Construction:

The first 8 digits specify the serial number: 0193 9251

Digit 9 and 10 the production plant in Fulda: 01

Digit 11 (second line) the hardware version: 0

Digit 12 and 13 the year: 2014

Digit 14 and 15 the calendar week: 16

Digit 16 to 19 consecutive numbers: 0045









```
SW versions  
257.02.01  
258.02.01  
258.02.01  
Production No.  
0193925101  
014160045  
Insp. ID 03109316
```

2.5 Service addresses

⇒ see last page

2.6 Approvals

	Designation Testing agency Certifikate no. Inspection basis Valid for	DIN DIN CERTCO STB/STW1223 DIN EN 14597 All device versions
	Designation Testing agency Certifikate no. Inspection basis Valid for	SIL2, SIL3 TÜV Nord SEBS-A.102606/16-1 V2.0 DIN EN 61508, DIN EN 60730-2-9, DIN EN 14597 Devices with extra code 058
	Designation Testing agency Certifikate no. Inspection basis Valid for	PL e TÜV Nord SEBS-A.102606/16-1 V2.0 DIN EN ISO 13849-1 Devices with extra code 058

	<p>Designation</p> <p>Testing agency</p> <p>Certifikate no.</p> <p>Inspection basis</p> <p>Valid for</p>	<p>UL</p> <p>Underwriters Laboratories</p> <p>File Nr.: E325456</p> <p>UL 60730-2-9, UL 60730-1, UL 60730-2-9, CAN/CSA-E60730-1, CAN/CSA-E60730-2-9</p> <p>All device versions</p>
	<p>Designation</p> <p>Testing agency</p> <p>Certifikate no.</p> <p>Inspection basis</p> <p>Valid for</p>	<p>DNV</p> <p>DNV</p> <p>TAA000017J</p> <p>DNV GL rules for classification - Ships, offshore units, and high speed and light craft</p> <p>Devices with extra code 062</p>
	<p>Designation</p> <p>Testing agency</p> <p>Certifikate no.</p> <p>Inspection basis</p> <p>Valid for</p>	<p>EAC</p> <p>Меридиан</p> <p>EAЭС N RU Д-DE.МН06.В.17659/19</p> <p>TP TC 004/2011, TP TC 020/2011</p> <p>All device versions</p>
	<p>Designation</p> <p>Testing agency</p> <p>Certifikate no.</p> <p>Inspection basis</p> <p>Valid for</p>	<p>UKCA</p> <p>All device versions</p>



This operating manual is a translation of the **German original manual**.

It is valid for the following hardware and software versions:

Diagnosis module from version: 257.02.01

Analog channel 1 from version: 258.02.01

Analog channel 2 from version: 258.02.01

and replaces the following old software versions:

Diagnosis module from version: 257.01.XX

Analog channel 1 from version: 258.01.XX

Analog channel 2 from version: 258.01.XX

* Press the **P** + **▲** keys

Keep the operating manual in a place accessible to all users at all times.



All necessary settings are described in this Operating Manual.

Handling the device in any way that is not described in the Operating Manual or that is expressly forbidden will jeopardize your warranty rights and may disable the safety function.

It is forbidden to access the inside of the device!

Repairs may only be performed by JUMO at the head office in Fulda.

Please contact the nearest subsidiary or the head office should you encounter any problems.

3 Installation

3.1 Dimensions

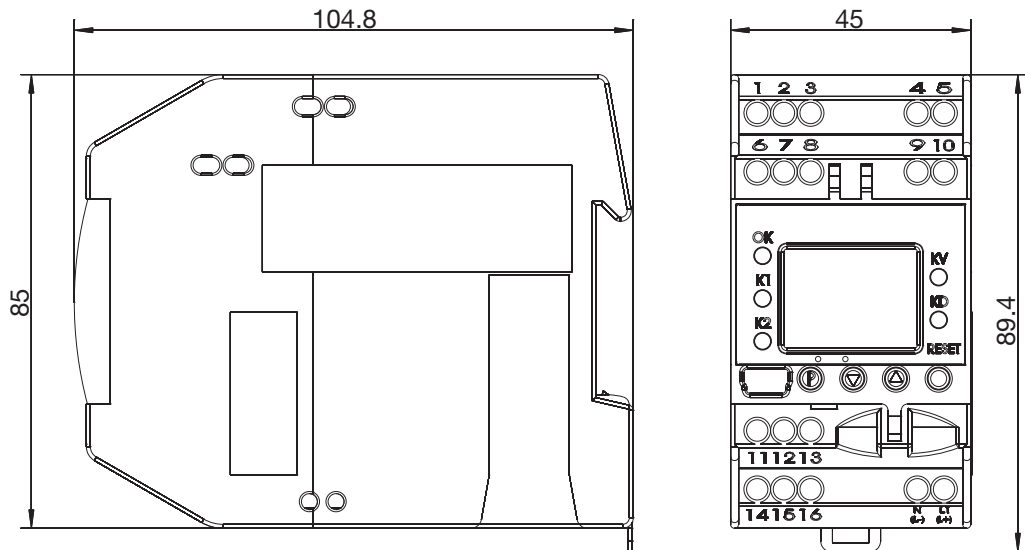

3.2 Installation location, DIN rail installation



The device is not suitable for use in potentially explosive atmospheres.
The device is hooked into a 35 mm DIN rail (EN 60715) from the front and pushed down to engage.

- ⇒ The ambient conditions at the installation site must meet the requirements specified in the technical data.
Chapter 8 "Technical data"

- As far as possible, the installation site should be vibration-free to prevent the screw-connections from working loose.
- The installation site should be free from aggressive media, e.g. acids and lyes, and, if possible, free from dust, flour or other suspended matter in order to prevent the cooling slots from becoming clogged.

3.3 Close mounting

- Observe a minimum spacing of 20 mm from the top and bottom.
 1. To allow the release slot to be accessed with a screwdriver from below.
 2. To allow the device to be swiveled up and unhooked from the DIN rail for removal.
- Several devices may be mounted side by side without a gap.

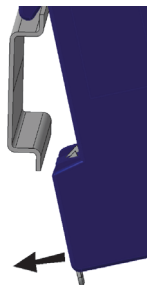

3.4 Dismantling

- * Insert a screwdriver into the release lug from below and lift up (1).
- * Simultaneously swivel the screwdriver and case up out of the DIN rail (2).

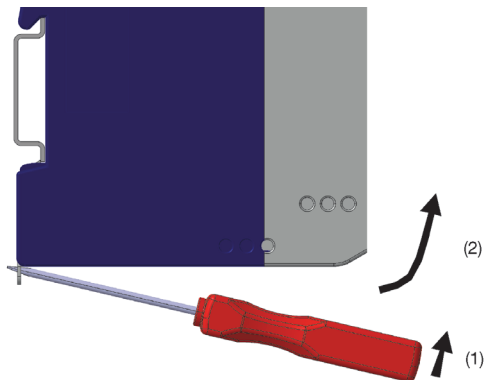

3.5 Electrical isolation

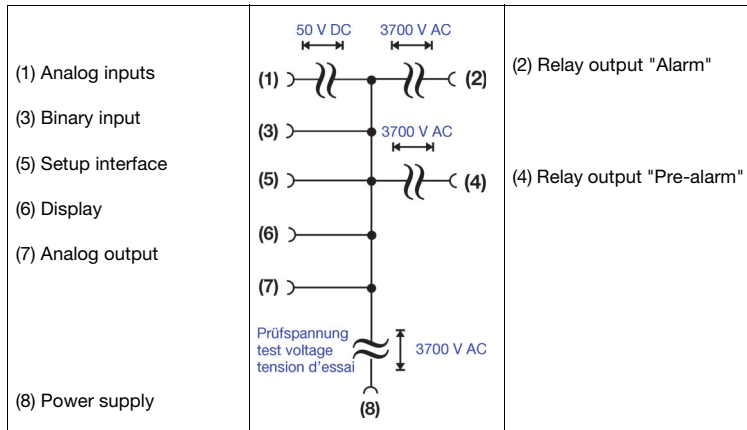

3.6 Use of the setup interface

- The setup interface USB is only designed for service use for a limited period, e.g. for transmitting setup data and during commissioning.
- It is not suitable for operation in a fixed installation for an unlimited period as the monitoring function is switched off during data transmission with the setup program.

4 Electrical connection

4.1 Installation notes

- Check that the safety temperature limiter is correctly installed for its application (temperature measurement) and is operated within the admissible system parameters.
- The device is designed for installation in switch cabinets, machines/plants or systems. Ensure that the customer's fuse rating does not exceed 20 A.
- Isolate the device at all poles prior to starting service or repair work.
- All incoming and outgoing lines without a connection to the power supply network must be laid with shielded and twisted lines. Connect the screen on the device side to ground.
- Do not run input and output lines close to current-carrying components or cables.
- Do not connect any additional consumers to the screw terminals for the device power supply.
- The choice of cable, the installation and the electrical connection of the device must conform to the requirements of VDE 0100 "Regulations on the Installation of Power Circuits with Nominal Voltages below 1000 V" or the appropriate local regulations.
- Protect the relay circuit by suitable measures.
The maximum contact rating is 230 V/3 A (ohmic load).
- The electromagnetic compatibility conforms to the standards and regulations cited in the technical data.
⇒ Chapter 8 "Technical data"
- During commissioning we recommend carrying out a trial run of the system until temperature switch-off at the set limit.



Only allow qualified electricians to carry out the electrical connection and the configuration settings until commissioning.



The approval according to DIN EN 14597 is only valid when the correct probe with DIN approval is set in the configuration level and also connected.

The limit value to be monitored must be within the admissible temperature range of the DIN probe.

⇒ Chapter 8.11 "Note for suitable probes"

⇒ Chapter 8.12 "Probes for the operating medium air"

The monitoring function is deactivated during data transmission using the setup program.









⇒ Chapter 12 "What to do, if ..."







4.2 Connection diagram

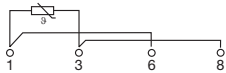

Connection is carried out via screw terminals.



Lead	Admissible cross section
1 wire	$\leq 2.5 \text{ mm}^2$
fine-strand, with core-end ferrule	$\leq 1.5 \text{ mm}^2$

Legend	Remark	Screw terminals	Screw terminals
1, 2		Analog input1 (E1)	Analog input2 (E2)
	Thermocouple/ double thermocouple		
	 When connecting double thermocouples the measuring circuits (E1) and (E2) have to be installed so that they are electrically insulated. That means that both thermocouples do not have an electrical connection to the protection fitting or each other. (insulated installation).		
	RTD temperature probe Pt100/Pt1000 in 2-wire circuit		
	 Enter the lead resistance for RTD temperature probes in two-wire circuit when using greater line lengths. ⇒ Setup program: <i>edit => analog inputs</i>		
	RTD temperature probe Pt100/Pt1000 in three-wire circuit		

Legend	Remark	Screw terminals	Screw terminals
	<p>RTD temperature probe Pt100 in two-wire circuit, individual probe for both analog inputs</p> <p>Caution: When only one probe (SIL2) is connected, the temperature limitation device is reduced from SIL3 to SIL2. However, the internal 2-channel structure (1oo2D) in the device is still retained. Both channels measure the same probe due to the simplified external circuit.</p>		
	<p>4 to 20 mA</p>		
	<p>4 to 20 mA for both analog inputs</p> <p>Caution: When only one probe (SIL2) is connected, the temperature limitation device is reduced from SIL3 to SIL2. However, the internal 2-channel structure (1oo2D) in the device is still retained. Both channels measure the same current signal due to the simplified external circuit.</p>		
<p>4</p>	<p>Binary input Connection to a potential-free contact</p>	<p>Ground</p> 	
<p>5</p>	<p>Analog output: 0 to 20 mA 4 to 20 mA (ex-factory) 0(2) to 10V</p>		

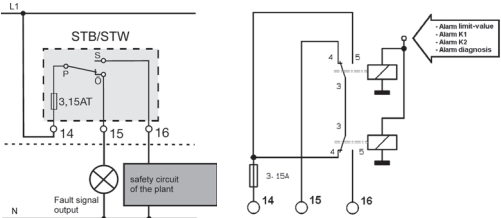
Legend	Remark	Screw terminals	Screw terminals
	<p>Caution</p> <p>The analog output is not part of the safety function!</p>		
9	<p>Voltage supply according to rating plate</p>	<p>AC: L1 Line conductor N Neutral</p> 	<p>DC: (L+) (L-)</p> 
10	<p>Relay output "Alarm" (current-free state) Relay (changeover contact element) with fuse cut-out</p>	 <p style="text-align: right;">Internal</p>	

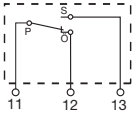
Legend	Remark	Screw terminals	Screw terminals
<p data-bbox="55 142 84 166">11</p> 	<p data-bbox="168 142 492 192">Relay output pre-alarm (KV) Changeover contact</p> <p data-bbox="168 319 722 410">Caution The pre-alarm relay output is not part of the safety function!</p>		

5 Commissioning the device

5.1 Display and operating elements

- * Connect the voltage supply - a test routine will start during which all LEDs will flash and the display with background lighting will indicate white pixels for 2 seconds and black pixels for 2 seconds.

Once the test routine has been completed, the device will indicate the main measured value (factory set).

⇒ If an alarm or error message appears, refer to Chapter 10 "Alarm messages".

5.2 Setting the display after switch-on

⇒ Chapter 7.6.4 "Normal display"

The screen is factory set to show the main measured value in German. The example shows the screen layout of a safety temperature limiter monitoring a maximum value of 29.6°C with a pre-alarm set to 9.9°C.



If the main measured value is within the hysteresis during "Power ON", the relay outputs "Pre-alarm" and "Alarm" are deactivated.

1 Switching behavior

7 Main measured value

6 Pre-alarm



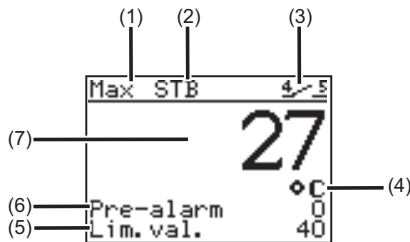

5 Limit value



2 Device function

3 Binary input

4 Temperature unit



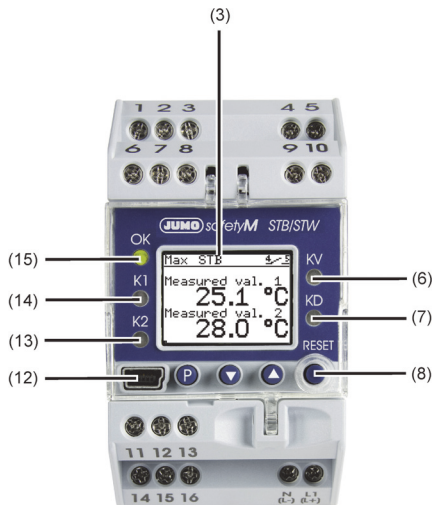

Legend	Remark
3	LCD display Black and white with background lighting 96 x 64 pixels
6	LED KV (yellow) Is lit if the relay output pre-alarm was triggered. (Relay output pre-alarm is active)
7	LED KD (yellow) Is lit if the diagnosis processor has switched off a component.
8	Keys (Can only be operated when the transparent hood is folded up) <ul style="list-style-type: none">  Increase value / previous parameter  Reduce value / next parameter  Programming  RESET
12	Setup interface
13	LED K2 (red) Is lit for all errors.
14	LED K1 (red) Is lit for all errors.
15	LED OK Green: OK range (no error) OFF: Error occurred

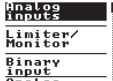

5.3 Selecting and editing parameters (plausibility inquiry for input values)

The values are displayed in the standard display.

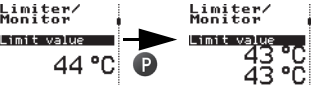
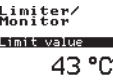
Carry out steps 1 to 4 to edit a value, e.g. in this case, the limit value



1	Press P		The first menu item "Analog inputs" has a black background. The vertical line on the right shows the current position.
2	Select limiter/monitor with ▼ Use P to change to the submenu		
3	Press ▼ 2x until the limit value appears Press P (limit value flashes)		
4	Use ▼ or ▲ to set the desired value Acknowledge with P (limit value is shown in duplicate)		Limit value flashes in duplicate on the display as a control.
5	Briefly press P to confirm the value. The value is applied and saved.		Use P + ▼ to return to the standard display or menu topic "Back" or return automatically after a timeout
	If no key is pressed, the device automatically returns to the standard display after 30 seconds (timeout) and the value is not saved. The length of the timeout is configurable. ⇒ see operating overview on the first inner page of this manual.		

5.4 Aborting edit

P + **▼** are used to abort editing and retain the previous value.

5.5 Alarm acknowledgement using the Reset key (only for temperature limiters STB)

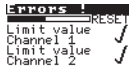
* Press **●** (RESET) key and hold down

Ticks appear after the errors		The alarm is no longer pending and is acknowledged as soon as the time bar has finished (3 seconds).
A bell is shown after the error.		The alarm condition is still pending and cannot be acknowledged.

5.6 Alarm acknowledgement via binary input (only for temperature limiters STB)

The binary input can be configured so that, for example, alarms can be unlocked via a potential-free contact.

The function only reacts to the switching flank from the "open" to the "closed" state.

The contact then behaves in the same way as the "Reset" button.

⇒ Chapter 7.4.1 "Function"

5.7 Lead sealing the device

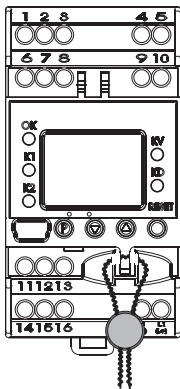

The device settings must not change under operating conditions.

A lead-sealed, transparent cover must therefore be placed over it to prevent unintentional or unauthorized adjustment.

Two holes are provided to the left and right of the transparent cover through which wire can be guided for lead sealing to connect the cover to the housing. The wire ends are secured with the lead seal.

6 Safety Manual

6.1 Brief description

The safety temperature limiter (**STB**) and safety temperature monitor (**STW**) enable early and reliable detection of risks which could potentially result in personal injuries, environmental damage, or destruction of the production plant and production materials.

Its task is to reliably monitor process variables such as temperature or pressure and to switch the plants to an operationally safe status in the event of malfunctions.

The measured value at the analog input can be recorded by various probes or standard signals.

Even when using double sensors (1oo2) only one physical measuring point is monitored at the measuring point.

Limit value exceedance is indicated by the installed LED K1 and K2 (red) for each channel. At the same time the integrated **safety tested Relay output "Alarm"** (screw terminals 14 and 16) switches the system to safe operating status (**alarm range**).

The SIL3 requirements of DIN EN 61508 or PLe DIN EN ISO 13849 are met by a device concept that has a 1oo2D structure which ensures reliable detection of errors.

6.2 Safety temperature monitor (STW)

The safety temperature monitor is a device that is automatically reset when activated once the sensor temperature has fallen below or risen above the set limit value by an amount equal to the switching differential. Possible settings: monitoring for limit value overrange or underrange.

Mode of operations:

- Minimum requirements: 2B, 2K, 2P
- Additional requirements: 2N, 2D

6.2.1 Safe operating status STW

The safe status is when the relay output alarm between terminals 14 and 16 is switched off (closed-circuit principle).

6.3 Safety temperature limiter (STB)

The safety temperature limiter is a device that is permanently locked after responding.

Manual reset using the ● (RESET) key is possible once the probe temperature has fallen below / has exceeded the limit value by the amount of the switching differential. Possible settings: monitoring for overrange or underrange.

Mode of operations:

- Minimum requirements: 2B, 2J, 2V, 2K, 2P and adjustable with special tools
- Additional requirements: 2N, 2F, 2D

6.3.1 Safe operating status STB

The safe status is when the relay output alarm between terminals 14 and 16 is switched off (closed-circuit principle).

This status is maintained until manual unlocking is performed in the valid range of the device.

The transparent, sealable protective cover prevents unauthorized operation.

The ● (RESET) key for manual unlocking can be accessed with the aid of a tool.

6.4 Relevant standards

Failure of the devices could affect the safety of persons and/or the safety of the environment.

Certification to DIN EN 61508 is provided because of the worldwide use of these systems.

The temperature monitoring unit type 701150 with extra code "058" meets the requirements

- For safety function to SIL3 according to DIN EN 61508 parts 1 to 7:
Functional Safety - Safety Related Electrical /Electronic / Programmable Electronic Systems
- DIN EN 61 511 Parts 1 to 3:
Functional Safety - Safety-Related Systems for the Process Industry
- DIN EN 14 597
Temperature Regulation Equipment and Temperature Limiter for Heat-Generating Systems
- DIN EN 60 730-2-9:

Automatic Electrical Control and Regulating Devices for Household Use and Similar Applications Parts 2-9: Special Requirements for Temperature-Dependent Control and Regulating Devices

- EN 61 326
- DIN EN ISO 13849-1 PL_e
- UL 60730-2-9

6.5 Validity of the Safety Manual



The evaluation described in this Safety Manual in terms of functional safety and display of certificates applies to the specified versions of temperature monitoring units including sensor versions.

Specifications that do not take the sensor system into consideration is identified as such.

6.6 Connection possibilities of the sensors (SIL)

The JUMO safetyM STB/STW 701150 evaluation device structure is basically identical. Various possibilities to connect the sensors are available. These possibilities are listed in the following table along with the achievable SIL level:

6.6.1 Achievable SIL

Variant	Connected sensors	architecture		Achievable SIL			
		Sensor system	Logic				
1	1 x Pt100 in 2-wire circuit, individual sensor	1oo1	1oo2D	2			
1a	2x Pt100/1000 2-wire circuit	1oo2	1oo2D	3			
2	2x Pt100/1000 3-wire circuit	1oo2	1oo2D	3			
3	2x thermocouple	1oo2	1oo2D	3			
4	1x Pt100/1000 2-wire and 3-wire circuit 1x thermocouple	1oo2	1oo2D	3			
5	STB/STW 701150 without sensor system 1oo2D architecture. No probe or use 4 to 20 mA (means that the sensor is not taken into account for the calculation).	Sensors connected by the system user Architecture acc. to connection 1oo1 or 1oo2	1oo2D	SIL of the used sensor (HW only)	systematic capability (SC) of the used sensor	max. achievable SIL of the system with 1oo1 sensor system architecture	max. achievable SIL of the system with 1oo2 sensor system architecture
				1	1	1	1
				1	2	1	2
				2	2	2	2
				2	3	2	3
3	3	3	3				

Important information:

Variants 1 to 4 were evaluated with JUMO probes according to data sheets 901006 and 902006. For variant 5 no sensor system was taken into account. In this case, the user selects the sensor system. For this reason, the user is responsible for evaluating the achievable SIL.

If the used SIL-capable sensor consists of hardware and software (e.g. transmitter), the maximum SIL that can be achieved – irrespective of the architecture – is the one according to which the sensor software was developed (so, for example, if the sensor software has SIL2, the max. achievable SIL is 2).

The possibility to connect passive sensors such as double thermocouples, Pt100 sensors, or Pt1000 sensors means that the sensors do not necessarily require a SIL qualification. In this case, the specification of the failure rates for the passive sensors is sufficient for the SIL qualification of the overall system. The user of the system must always determine the PFD_{avg} and/or PFH value of the overall safety chain to evaluate the achieved SIL.

Requirements regarding proof-check interval and lifetime apply only in terms of functional safety.

Requirements as specified by DIN EN 14 597 are defined in the Operating Manual B 701150 and are independent of the requirements of this Safety Manual.

Temperature probe

Admissible measuring ranges must be observed for devices with approval according to DIN EN 14 597 and SIL certification. If other temperature probes than those described by JUMO data sheets 901006 and 902006 are used, their registration and suitability for use must be verified.

Use insulated connecting points for double thermocouples

For safety related reasons the measuring circuits of **double thermocouples** have to be installed so that they are electrically insulated. That means that both thermocouples do not have an electrical connection to the protection fitting or each other. (insulated installation).

6.7 Standards and definitions

6.7.1 Terms and abbreviations acc. to DIN EN 14597

Abbreviation	Explanation
Type 2	Mode of operation for which the manufacturing variation and migration of the operating value, operating duration, or operating procedure has been checked.
Type B	Micro disconnection in operation, corresponding contact disconnection at at least one pole to provide functional reliability.
Type D	A free trip mechanism that also cannot be closed temporarily for as long as the error persists.
Type F (STB)	A mode of operation in which, after the RS has been installed, it can only be reset with the aid of a tool.
Type J (STB)	A free trip mechanism with contacts that cannot be prevented from opening and which may not function as an automatically resetting RS if the means of resetting is held in the "Reset" or "On" position.
Type K	A probe mode of operation in which a probe break or a disconnection between the probe head and the switching head does not cause the operating value to increase.
Type N	A mode of operation in which the operating value does not increase as a result of a leak in the probe or in the parts that connect the probe and switching head. This mode is intended for use with electrical error models.
Type V (STB)	A lockout that can only be reactivated through a manual reset.
Type P	A mode of operation that is effective following a specified test through a change in temperature, as specified in 17.101 of DIN EN 60730-2-9.

6.7.2 Terms and abbreviations acc. to DIN EN 61 508 and DIN EN 61 511.

Name	Description
Actuator	Part of a safety-related system that intervenes in the process to achieve a safe state.
EUC	EUC (equipment under control) Equipment, machine, apparatus, or system used for manufacturing, shaping materials, for transport, medical purposes, or other activities.
E / E / PE	Electrical/electronic/programmable electronic (E/E/EP): based on electrical (E) and/or electronic (E) and/or programmable electronic (PE) technology
Failure	End of the ability of a functional unit to perform a required function.
Diagnostic coverage	Partial reduction in the probability of dangerous hardware failures due to the use of automatic diagnostic tests.
Errors	A non-normal condition that can cause a reduction or the loss of the ability of a functional unit to perform a required function.
Functional safety	A part of overall safety related to the EUC and EUC control system that depends on the correct function of the E/E/EP safety-relevant system, safety-relevant systems of other technology, and external equipment for risk reduction.
Functional unit	Unit consisting of hardware or software or both that is suitable for performing a specified task.
Dangerous failure	A failure with the potential of placing the safety-related system in a dangerous state or a state without functional capability.
Safe failure	A failure without the potential of placing the safety-related system in a dangerous state or state without functional capability.
Hazard	Potential source of damage
Security	Absence of unjustifiable risks

Name	Description
Safety function	A function that is performed by an E / E / PE safety-related system, safety-related system based on some other technology, or external equipment for reducing risk with the goal of achieving or maintaining a safe state for the EUC taking into consideration a specified dangerous event.
Safety integrity	The probability that a safety-related system will perform the required safety function under all specified conditions within a specified period of time according to requirements.
Safety Integrity Level (SIL)	One of four discrete levels for specifying the requirement for safety integrity of the safety functions assigned to the E/E/PE safety related system. Safety Integrity Level 4 represents the highest level of safety integrity, while Safety Integrity Level 1 represents the lowest.
Safety-related system	A system that - performs necessary safety functions that are required to reach or maintain a safe state for the EUC and - is designed by itself or with other E / E / PE safety-related systems of other technology or external equipment for risk reduction to achieve the necessary safety integrity for the required safety functions.
Safety Instrument System (SIS)	Safety instrumented system to perform one or more safety-related functions. A SIS consists of sensor(s), logic system, and actuator(s).
Lambda: λ	Failure rate per hour
Lambda dangerous: λ_D	Rate of dangerous failures per hour
Lambda Δ dangerous Δ detect: λ_{DD}	Rate of detected dangerous failures per hour
Lambda Δ dangerous Υ ndetect: λ_{DU}	Rate of undetected dangerous failures per hour
Lambda: λ_S	Rate of safe failures per hour
Lambda: λ_{SD}	Rate of detected safe failures per hour

Name	Description
Lambda: λ_{SU}	Rate of undetected safe failures per hour
BPCS	Basic Process Control System
DC	D iagnostics C overage
FIT	Failures In Time (1×10^{-9} per h)
HFT	Hardware Fault Tolerance
PFD	Probability of Failure on Demand
PFD _{avg}	Average Probability of Failure on Demand
MooN	Architecture with M from N channels
MTBF	Mean Time Between Failures
MTTR	Mean Time To Repair
SFF	Safe Failure Fraction
SIL	Safety Integrity Level
PFH	Probability of dangerous failure per hour

6.8 Safety instrumented parameters related to the temperature monitoring unit

The following parameters were calculated by means of an FMEDA component under the following conditions:

- Error models corresponding to requirements of DIN EN 61508 for conformity with SIL2 or SIL3
- Failure rate of components according to the RDF 2000 UTE C 80-810 standard and SN 29500
- Sensors were combined as a subsystem in the following five variants:

6.8.1 Failure rates and SFF for 701150...23 (AC 230 V)

Variant	λ_s [Fit]	λ_{dd} [Fit]	λ_{du} [Fit]	SFF	PFH (1/h)	PDF _{avg}
1	865.21	306.24	32.31	96 %	4.56 e ⁻⁹	2.02 e ⁻⁴
1a	865.21	306.24	32.31	96 %	1.05 e ⁻⁹	4.57 e ⁻⁵
2	868.17	303.28	32.31	96 %	1.05 e ⁻⁹	4.57 e ⁻⁵
3	881.62	326.78	33.62	96 %	1.03 e ⁻⁹	4.49 e ⁻⁵
4	887.68	343.82	35.52	96 %	1.22 e ⁻⁹	5.30 e ⁻⁵
5	881.02	313.43	35.57	96 %	1.04 e ⁻⁹	4.48 e ⁻⁵

Important information:

Variants 1 to 4 were evaluated with JUMO probes according to data sheets 901006 and 902006.

For variant 5 no sensor system was taken into account.

In this case, the user selects the sensor system.

6.8.2 Failure rates and SFF for 701150...25 (AC/DC 24 V)

Variant	λ_s [Fit]	λ_{dd} [Fit]	λ_{du} [Fit]	SFF	PFH (1/h)	PFD _{avg}
1	799.3	306.32	33.61	96 %	$6.59 \cdot 10^{-9}$	$2.91 \cdot 10^{-4}$
1a	799.3	306.32	33.61	96 %	$3.07 \cdot 10^{-9}$	$1.35 \cdot 10^{-4}$
2	802.26	303.36	33.61	96 %	$3.07 \cdot 10^{-9}$	$1.35 \cdot 10^{-4}$
3	827.25	324.71	37.91	96 %	$3.13 \cdot 10^{-9}$	$1.37 \cdot 10^{-4}$
4	833.31	341.75	39.81	96 %	$3.23 \cdot 10^{-9}$	$1.41 \cdot 10^{-4}$
5	818.96	323.07	36.26	96 %	$3.05 \cdot 10^{-9}$	$1.33 \cdot 10^{-4}$

Important information:

Variants 1 to 4 were evaluated with JUMO probes according to data sheets 901006 and 902006.

For variant 5 no sensor system was taken into account.

In this case, the user selects the sensor system.

The PFH and PFD_{avg} values were calculated with the assumption that the time to restore the system is 8 h (MTTR = 72 h). Furthermore, the calculation was based on a lifetime of 10 years ($T_1 = 10 \text{ y}$). The Common Cause Factor was determined according to the tables of DIN EN 61508 for sensor systems and logic.

6.9 Determining the Safety Integrity Level (SIL)

The achievable Safety Integrity Level is determined by the following safety-related parameters:

- Average probability of dangerous failures of a safety function on demand (PFD_{avg}),
- Hardware Fault Tolerance (HFT) and
- Safe Failure Fraction (SFF).

The specific safety-related parameters for the 701150 measuring system may be found in the table of the "Safety-related parameters" chapter.

The following table shows how the "Safety Integrity Level" (SIL) depends on the "average probability of dangerous failures of a safety function of the entire safety-related system" (PFD_{avg}) according to DIN EN 61 508. The "low demand mode" is considered, i. e. the demand rate for the safety-related system averages once a year.

Table High Demand PFH

Safety Integrity Level (SIL)	Operating mode with high demand rate PFH (high demand mode)
4	$\geq 10^{-9}$ to $< 10^{-8}$
3	$\geq 10^{-8}$ to $< 10^{-7}$
2	$\geq 10^{-7}$ to $< 10^{-6}$
1	$\geq 10^{-6}$ to $< 10^{-5}$

Table Low Demand PFD

Safety Integrity Level (SIL)	Operating mode with low demand rate PFD_{avg} (low demand mode)
4	$\geq 10^{-5}$ to $< 10^{-4}$
3	$\geq 10^{-4}$ to $< 10^{-3}$
2	$\geq 10^{-3}$ to $< 10^{-2}$
1	$\geq 10^{-2}$ to $< 10^{-1}$

The sensor, logic unit, and actuator together form a safety-related system that performs a safety function. The "average probability of dangerous failures of the entire safety-related system" (PFD_{avg}) is usually divided up into the sensor, logic unit, and actuator subsystems according to the following diagram.

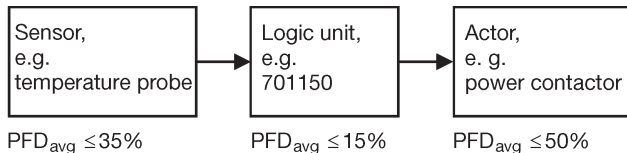

Typical subdivision of the "average probability of dangerous failures of a safety function on demand" (PFD_{avg}) into subsystems

The specifications related to functional safety in this Safety Manual include sensor systems (resistance temperature sensors, thermocouples), logic unit (701150), and (as signal contact) the relay output in the 701150 system.

The actuator (for example a power contactor) is system-related and must be taken into consideration separately according to the standard for the safety loop.

6.9.1 Safety integrity of the hardware

According to DIN EN 61 508, a distinction must be made between systems of type A and systems of type B.

A subsystem can be considered to be type A if, for the components required to achieve the safety function,

- the failure behavior of all components used is sufficiently defined; and
- the behavior of the subsystem can be fully determined under failure conditions; and
- reliable failure data from experience in the field exists for the subsystem to show that the assumed failure rates for detected and undetected dangerous failures are achieved.

A subsystem can be considered to be type B if, for the components required to achieve the safety function,

- the failure behavior of at least one of the components used is not sufficiently defined; or
- the behavior of the subsystem cannot be fully determined under failure conditions; or
- no sufficiently reliable failure data from experience in the field exists for the subsystem to support the utilized failure rates for detected and undetected dangerous failures.

The 701150 temperature monitoring unit corresponds to a type B system.

The following table shows the achievable Safety Integrity Level (SIL) in dependency on the proportion of non-dangerous failures (SFF) and the hardware fault tolerance (HFT) for safety-related type B subsystems.

For 701150 the following table applies:

Safe Failure Fraction (SFF)	Hardware fault tolerance (HFT) for type B		
	0	1	2
<60 %	Not allowed	SIL1	SIL2
60 to <90 %	SIL1	SIL2	SIL3
90 to <99%	SIL2	SIL3	SIL4
≥99 %	SIL3	SIL4	SIL4

6.9.2 Safety-relevant system properties

Device versions differ in the following architectures:

The evaluation unit from 701150 in STW, STB versions is implemented as 1oo2D architecture.

The types with an individual sensor are executed in one-channel sensor systems (1oo1).

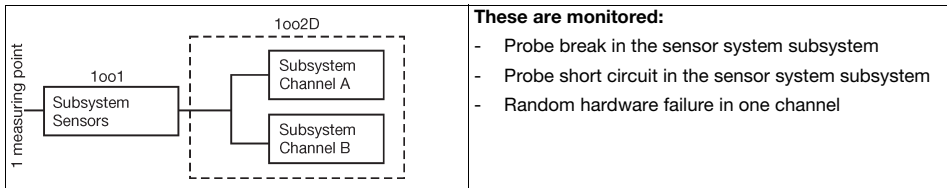

The variants with two sensors are consistently structured with two channels.

The two subsystems have to be galvanically isolated from each other.

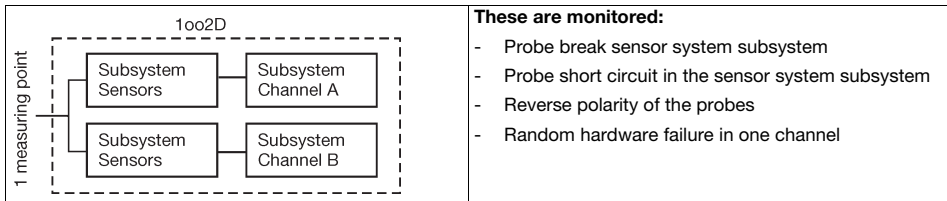

Systems have a lifetime of ten years.

The proof check for SIL2 and SIL3 certified systems is also ten years.

If the temperature is above/below the permissible limits, the system switches to the safe state without delay. Premature switching is admissible if a malfunction is detected.

Safety feature	Requirement / comment	
SIL The sensor system is included in the SIL evaluation.	SIL2	SIL3
Operating mode concerning safety function	Operating mode with lower and higher demand rate possible on a customer-specific basis	
Safety-critical inputs	Temperature sensor inputs 4 to 20 mA, current loop	
Safety-relevant inputs	Setup and parameterization	
Safety-critical output	Alarm contact limit value	
Subsystem type	Type B	
Safety architecture (logic unit JUMO STB/STW 701150)	1oo2D	
Safety architecture (sensor system)	SIL2 1oo1	SIL3 1oo2
Hardware error tolerance (logic unit JUMO STB/STW 70.1150)	HFT=1	
Hardware error tolerance (sensor system)	SIL2: HFT=0	SIL3: HFT=1
Proportion of safe errors	SIL2 sensor system HFT=0: 90 % to < 99 %	SIL3 sensor system HFT=1: 90 % to <99 %
CCF	Calculation according to DIN EN 61508 Part 7 Appendix D and/or DIN EN ISO 13849-1 Table F.1 min. 65 %	
Average failure probability of a safety function on demand (overall system)	SIL2: Low demand: $PFD_{avg} < 10^{-2}$ High demand: $PFH < 10^{-6}$	SIL3: Low demand: $PFD_{avg} < 10^{-3}$ High demand: $PFH < 10^{-7}$
Interval for repeat test	No repeat test	

Safety feature	Requirement / comment	
Planned operating duration	10 years	
Architecture according to DIN EN ISO 13849-1	Sensor system, one-channel: Cat. 2	Sensor system, two-channel: Cat. 3
MTTF _d -DC _{avg} according to DIN EN ISO 13849-1 table K.1	PL d: ≥ 62 years DC _{avg} ≥ 60 %	PL e: ≥ 62 years DC _{avg} ≥ 90 %
Mode of operation and software class according to DIN EN 14597	JUMO STB/STW 701150 possesses the following mode of operations 2B, 2D, 2F, 2K, 2J, 2V, 2N, 2P software class C	

6.10 Determining the achieved Performance Level PL

The following safety-related parameters are required to determine the Performance Level of components/devices:

As further parameters to be observed, operational aspects such as the demand rate and/or the test rate of the safety function can also influence the resulting PL.

Excerpt from DIN EN ISO 13849-1



This excerpt contains references to the complete standard DIN EN ISO 13849-1 which are therefore not reproduced in this chapter.

6.10.1 Terms and abbreviations acc. to DIN EN ISO 13849

Formula symbol or abbreviation	Description	Definition or location
PL (a, b, c, d, e)	Description for the Performance Level	Table 3

Formula symbol or abbreviation	Description	Definition or location
AOPD	Active Opto-Electronic Protective Device (e.g. light barrier)	Appendix H
B, 1, 2, 3, 4	Description for the categories	Table 7
B _{10d}	Number of cycles in which a dangerous failure occurred in 10 % of a random sample of the observed pneumatic or electromechanical components that are subject to wear (mean time to dangerous failure)	Appendix C
Cat.	Category	3.1.2
CC	Current converter	Appendix I
CCF	Common Cause Failure	3.1.6
DC	Diagnostic Coverage	3.1.26
DC _{avg}	Average diagnostic coverage	E.2
F, F1, F2	Frequency and/or duration of the exposure to danger	A.2.2
FB	Function block	4.6.3
FVL	Programming language with unlimited language range	3.1.35
FMEA	Failure Modes and Effects Analysis	7.2
I, I1, I2	Input device, e.g. sensor	6.2
i, j	Index for counting	Appendix D
I/O	Inputs/outputs	Table E.1
<i>i</i> _{ab} , <i>i</i> _{bc}	Fasteners	Image 4
K1A, K1B	Contactors	Appendix I
L, L1, L2	Logic	6.2
LVL	Programming language with limited language range	3.1.34

Formula symbol or abbreviation	Description	Definition or location
M	Motor	Appendix I
MTTF	Mean Time To Failure	Appendix C
MTTF _c	Mean time to critical failure	3.1.25
MTTF _d	Mean time to dangerous failure	
n, N, \bar{N}	Number of units	6.3, D.1
M_{low}	Number of SRP/CS with PL _{low} in an SRP/CS combination	6.3
O, O1, O2, OTE	Output device, e.g. drive unit	6.2
P, P1, P2	Possibility of avoiding the danger	A.2.3
PES	Programmable electronic system	3.1.22
PL	Performance Level	3.1.23
PLC	Programmable Logic Controller	Appendix I
PL _{low}	Lowest Performance Level of a SRP/CS in an SRP/CS combination	6.3
PL _f	Required Performance Level	3.1.24
r_a	Demand rate	3.1.30
RS	Rotary encoder	Appendix I
S, S1, S2	Severity of violation	A.2.1
SW1A, SW1B, SW1	Position switch	Appendix I
SIL	Safety Integrity Level	Table 4
SK (Cat.)	Category (B, 1, 2, 3, 4), structure as basis to achieve a certain PL	
SRASW	Safety-Related Application Software	4.6.3

Formula symbol or abbreviation	Description	Definition or location
SRESW	Safety-Related Embedded Software	4.6.2
SRP	Safety-Related Part	General
SRP/CS	Safety-Related Part of (a) Control System(s)	3.1.1
Sub-PL/Sub-SIL	PL or SIL at subsystem level. A subsystem a system that – based on a subtask – already adequately performs a safety function (for example, an input module that reliably records the inputs).	
TE	Test facilities	6.2
T_M	Functional life	3.1.28
T_M	Functional life, designated Mission Time	
$T_{10d\text{-value}}$	Reference value for a preventative exchange (10 % of the B10d value). At this value, a dangerous failure has already occurred for approx. 63 % of all components. In this case, the standard DIN EN ISO 13849-1:2006 recommends replacement.	

6.11 Connection possibilities of the sensors (PL)

The JUMO safetyM STB/STW 701150 evaluation device structure is basically identical.

Various possibilities to connect the sensors are available. These possibilities are listed in the following table along with the achievable PL level:

Variant	Connected sensors	Sensor system architecture	Logic architecture	Achievable PL		
1	1 x Pt100 in 2-wire circuit individual sensor	1oo1	1oo2D	PLd		
1a	2x Pt100/1000 2-wire circuit	1oo2	1oo2D	PLe		
2	2x Pt100/1000 3-wire circuit	1oo2	1oo2D	PLe		
3	2x thermocouple	1oo2	1oo2D	PLe		
4	1x Pt100/1000 2-wire and 3-wire circuit 1x thermocouple	1oo2	1oo2D	PLe		
5	STB/STW 701150 without sensor system 1oo2D architecture. No probe or use 4 to 20 mA. (means that the sensor is not taken into account for the calculation).	Sensors connected by the system user Architecture acc. to connection 1oo1 or 1oo2	1oo2D	PL of the used sensor	Max. achievable PL of the system with 1oo1 sensor system architecture $DC_{701150} \geq 90\%$	Max. achievable PL of the system with 1oo2 sensor system architecture $DC_{701150} \geq 90\%$
				PLb	PLd	PLe
				PLc	PLd	PLe
				PLd	PLd	PLe
				PLe	PLe	PLe

Important information:

Variants 1 to 4 were evaluated with JUMO probes according to data sheets 901006 and 902006. For variant 5 no sensor system was taken into account. In this case, the user selects the sensor system. For this reason, the user is responsible for evaluating the achievable PL.

6.11.1 Calculations DIN EN ISO 13849-1 Performance Level - low voltage 230 V

Variant	MTTF _d	DC _{avg}	CCF	PL
1	100 years ³ (337 years)	90 %	80	PLd
1a	100 years ³ (337 years)	90 %	80	PLe
2	100 years ³ (340 years)	90 %	80	PLe
3	100 years ³ (317 years)	91 %	80	PLe
4	100 years ³ (313 years)	91 %	80	PLe
5	100 years ³ (327 years)	91 %	80	See above table

6.11.2 Calculations DIN EN ISO 13849-1 Performance Level - extra low voltage (ELV) 24 V

Variant	MTTF _d	DC _{avg}	CCF	PL
1	100 years ³ (336 years)	90 %	80	PLd
1a	100 years ³ (336 years)	90 %	80	PLe
2	100 years ³ (339 years)	90 %	80	PLe
3	100 years ³ (315 years)	90 %	80	PLe
4	100 years ³ (311 years)	90 %	80	PLe
5	100 years ³ (318 years)	90 %	80	See above table

3. The MTTF_d value of a partial system must be limited to 100 years according to the DIN EN ISO 13849-1 requirements.

6.11.3 Contribution to risk minimization through the control system

The objective of compliance with the overall draft procedure for the machine is to achieve the safety objectives (see 4.1). The draft of the SRP/CS to provide the required risk minimization is an integral part of the overall draft procedure for the machine. The SRP/CS provides the safety function(s) with a PL that achieves the required risk minimization. Through the provision of safety functions, either as an inherently safe part of the construction or as the control of a protective guard or protective device, the design of the SRP/CS is part of the risk minimization strategy. This is an iterative process and is depicted in images 1 and 3.

The features of each safety function (see section 5) and the required Performance Level must be described and documented in the specification of the safety requirements.

In this part of DIN EN ISO 13849, the Performance Levels are defined in the form of the probability of a dangerous failure per hour. Five Performance Levels (a to e) are specified with defined areas of the probability of a dangerous failure per hour (see table).

Performance Level (PL)	Average probability of a dangerous failure per hour 1/h
a	$\geq 10^{-5}$ to $< 10^{-4}$
b	$\geq 3 \times 10^{-6}$ to $< 10^{-5}$
c	$\geq 10^{-6}$ to $< 3 \times 10^{-6}$
d	$\geq 10^{-7}$ to $< 10^{-6}$
e	$\geq 10^{-8}$ to $< 10^{-7}$

NOTE: in addition to the average probability of a dangerous failure per hour, further measures are required to achieve the PL.

Schematic representation of a combination of safety-related parts of controls for processing a typical safety function

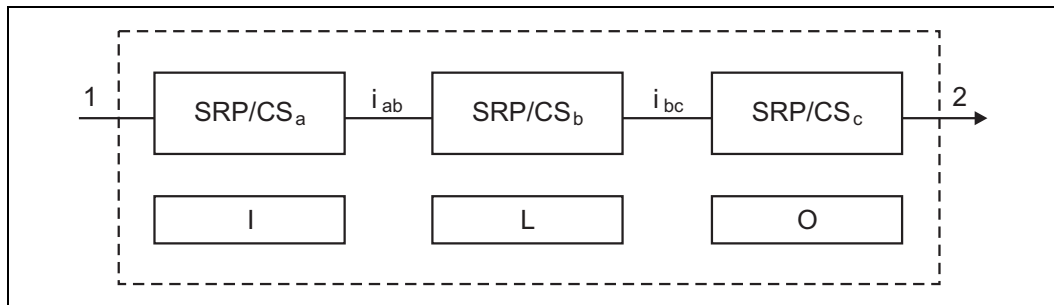

I Input

L Logic

O Output

1 Start event, e.g. manual actuation of a button, opening of a protective guard, interruption of the beam of an AOPD

2 Drive unit of the machine, e.g. motor brake

6.12 Evaluating the achieved Performance Level PL and the relationship to the SIL

For application in this part of DIN EN ISO 13849, the capability of safety-related parts to perform a safety function is expressed through the determination of a Performance Level.

The PL must be assessed for each selected SRP/CS and/or SRP/CS combination that performs a safety function. The PL of the SRP/CS must be determined by assessing the following aspects:

- The $MTTF_c$ value of individual components (see Appendices C and D)
- The DC (see Appendix E)
- The CCF (see Appendix F)
- The structure (see section 6)
- The behavior of the safety function under failure conditions (see section 6)
- Safety-related software (see 4.6 and Appendix J)
- Systematic failures (see Appendix G)
- The capability to perform a safety function under predictable ambient conditions

The following diagram depicts the procedure for selecting the categories in combination with $MTTF_d$ for each channel and the DC_{avg} to achieve the required PL for each safety function.

Relationship between the categories DC_{avg} , $MTTF_d$ of each channel and PL

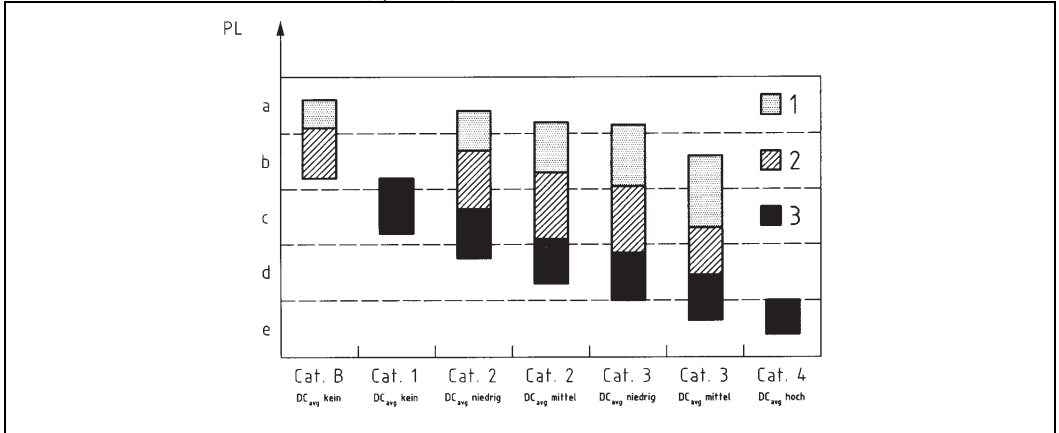

PL Performance Level

1 $MTTF_d$ of each channel = low

2 $MTTF_d$ of each channel = medium

3 $MTTF_d$ of each channel = high

The diagram above shows the different possible combinations for assessing the category with DC_{avg} (horizontal axis) and the $MTTF_d$ of each channel (bars). The bars in the diagram show the three $MTTF_d$ areas of each channel (low, medium and high) that can be selected to achieve the required PL.

Before the simplified procedure from the diagram shown is applied (which shows the results of different Markov models on the basis of intended architectures from section 6), the category of the SRP/CS and the DC_{avg} and the $MTTF_d$ of each channel must have been determined (see section 6 and Appendices C to E).

For categories 2, 3, and 4, sufficient measures against failures due to combined failures must be fulfilled (see Appendix F). Taking these parameters into account, the diagram represents a graphical procedure for determining the PL achieved by the SRP/CS. The combination of category (including failures due to combined failures) and DC_{avg} determines which column must be selected in image 5. In accordance with the $MTTF_d$ of each channel, one of the three differently hatched areas of the applicable column must be selected.

The vertical position of these areas determines the achieved PL, which can be read off the vertical axis. If the area covers two or three possible PLs, the achieved PL is specified in table 7. To select the exact PL on the basis of the precise value of the $MTTF_d$ of each channel, see Appendix K.

6.13 Other applicable device documentation

For temperature monitoring unit 701150 the measures, values, and requirements specified in this Operating Manual regarding installation, electrical connection, function, and startup must be observed.

6.14 Behavior during operation and in case of malfunction

Behavior during operation and in case of a malfunction is described in the Operating Manual.

A functional test must be performed after startup, repair in the safety system, or a change in safety-related parameters.

If an error is detected during a functional test, measures must be taken to once again ensure the functional capability of the safety system. This, for example, can be done by replacing the logic unit.

Appropriate documentation of tests that are performed is recommended.

6.15 Regular tests

No test is required for SIL2 and SIL3 certified systems since the proof check equals the lifetime. Each is ten years.



After the lifetime expires, the systems no longer meet the requirements according to their SIL certification.

6.15.1 Recommended tests for temperature probes

To ensure safe and reliable operation of the thermometer (including the commissioning), the following service and maintenance work must be performed:

The following tests are recommended at certain intervals:

As described in the table below, the leakage resistance of the measuring circuit must be measured against the protection fitting (for thermocouples: only for the insulated measuring circuit; in the case of multiple measuring circuits, the insulation test must also be performed between the individual measuring circuits). The minimal leakage resistance at room temperature should be 100 M Ω at DC 100 V.

- Damage and corrosion of thermometers – protection tubes

- Clear assignment of sensor and associated thermowell/protective sleeve by checking the installation depth
- Corrosion and correct positioning of the contacts and terminals of cable connections
- Seals of terminal heads and cable ducts
- Interruptions due to "knocking, shaking" on the thermometer/measuring insert

Since the maximum operating temperature influences the drift behavior, the thermometer should be recalibrated or replaced at certain intervals to ensure reliable and precise temperature measurement.

The testing intervals are listed in the table below:

Maximum operating temperature	Pt - RTD temperature probe	Thermocouples
200 °C	5 years	5 years
550 °C	2 years	5 years
700 °C	1 year	2 years
1000 °C		Non-precious metal 1 year
		Precious metal 2 years
1500 °C		1 year



The testing intervals specified here are recommendations that must be adapted to the special conditions at the operating location and, if necessary, the user should perform the tests more regularly.

7 Configuration level

7.1 Navigation principle

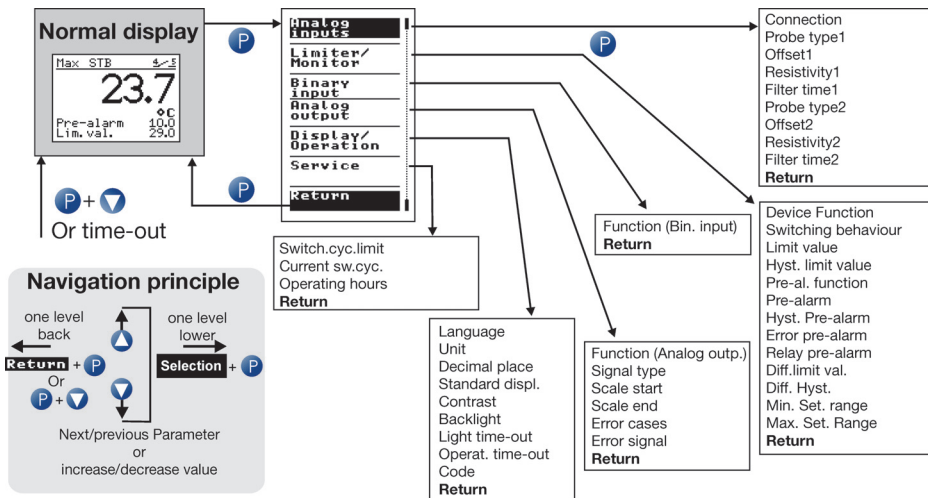



All the parameters are freely accessible at the factory, but they can be disabled via the setup program.

⇒ Chapter 9.3 “Forgotten the code?”

Parameters of the configuration level which are not required are automatically hidden depending on the setting.

7.2 Analog inputs

7.2.1 Connection		Comment
Two sensors		This setting is provided for dual probes or for two different probes. Each of the two analog inputs is monitored separately for probe break, probe short-circuit.
Single Pt100 in 2-wire circuit		Caution: When only one probe (SIL2) is connected, the temperature limiter device is reduced from SIL3 to SIL2! However, the internal 2-channel structure (1oo2D) in the device still remains. Both channels measure the same sensor due to the simplified external wiring.
Single 4 to 20 mA		Caution: When only one probe (SIL2) is connected, the temperature limiter device is reduced from SIL3 to SIL2! However, the internal 2-channel structure (1oo2D) in the device still remains. Both channels measure the same current signal due to the simplified external wiring.

■ Factory setting

7.2.2 Sensor type 1 For analog input 1	Comment	Setting range for limit value: (can be restricted via the setup)	Limits for Underrange / overrange
Pt100 DIN EN 60751	In 3-wire circuit IEC 60751:2008	-1999 to +9999 °C	-205 °C/ +855 °C
Pt1000 DIN EN 60751	In 3-wire circuit IEC 60751:2008	-1999 to +9999 °C	-205 °C/ +855 °C
Pt100 DIN EN 60751	in 2-wire circuit IEC 60751:2008	-1999 to +9999 °C	-205 °C/ +855 °C
Pt1000 DIN EN 60751	in 2-wire circuit IEC 60751:2008	-1999 to +9999 °C	-205 °C/ +855 °C
W3Re-W25Re "D"	Thermocouple ASTM E1751M-09 (bis 2315 °C): 2009	-1999 to +9999 °C	-5 to +2500 °C
W5Re-W26Re „C“	Thermocouple ASTM E230M-11: 2011	-1999 ... +9999°C	-5 ... +2320°C
Cu-CuNi "T"	Thermocouple DIN EN 60584-1: 1996-10	-1999 to +9999 °C	-205 to +405 °C
Fe-CuNi "J"	Thermocouple DIN EN 60584-1: 1996-10	-1999 to +9999 °C	-205 to +1205 °C
Cu-CuNi "U"	Thermocouple DIN 43710: 1985-12	-1999 to +9999 °C	-205 to +605 °C
Fe-CuNi "L"	Thermocouple DIN 43710: 1985-12	-1999 to +9999 °C	-205 to +905 °C
NiCr-Ni "K"	Thermocouple DIN EN 60584-1: 1996-10	-1999 to +9999 °C	-205 to +1377 °C
Pt10Rh-Pt "S"	Thermocouple DIN EN 60584-1: 1996-10	-1999 to +9999 °C	-55 to +1773 °C
Pt13Rh-Pt "R"	Thermocouple DIN EN 60584-1: 1996-10	-1999 to +9999 °C	-55 to +1773 °C

7.2.2 Sensor type 1 For analog input 1	Comment	Setting range for limit value: (can be restricted via the setup)	Limits for Underrange / overrange
Pt30Rh-Pt6Rh "B"	Thermocouple DIN EN 60584-1: 1996-10	-1999 to +9999 °C	295 to 1825 °C
NiCrSi-NiSi "N"	Thermocouple DIN EN 60584-1: 1996-10	-1999 to +9999 °C	-105 to +1305 °C
4 to 20 mA	Standard signal	-1999 to +9999 °C	3.6 to 21 mA

■ Factory setting

Parameter	Comment	Value range (factory-setting in bold)
7.2.3 Offset 1	Using Offset1, a measured value at the analog input can be corrected by the value entered above the total measuring range.	-999.9 to 0.0 to 999.9
7.2.4 Lead wire resistance 1 (resistivity)	Analog-input1 lead wire resistance in 2-wire circuit This value is used to compensate the resistance of the probe line and depends on the line length. Enter the ohmic resistance of the probe line here to achieve the best possible temperature measurement.	0.0 to 30.0 ohm

Parameter	Comment	Value range (factory-setting in bold)
7.2.5 Filter time 1	<p>Time constant of the digital input filter 2nd order for analog input 1 If the input signal changes suddenly, approx. 26 % of the change is recorded following a period that corresponds to the filter time constant dF (2 x dF: approx. 59 %; 5 x dF: approx. 96 %). Value 0 means: filter switched off</p> <p>If the filter time is long: - Interfering signals are better absorbed - Measured value display responds more slowly to changes</p>	0.0 to 0.6 to 100 sec.
7.2.6 Scaling start 1	<p>Important information: This setting only occurs if the sensor type 1 was set to 4 to 20mA!</p> <p>Here, the user selects which value (i.e. pressure) should be displayed at 4 mA.</p>	-9999 to 0 to 9999
7.2.7 Scaling end 1	<p>Here, the user selects which value (i.e. pressure) should be displayed at 20 mA.</p>	-9999 to 100 to 9999

7.2.8 Sensor type 2 For analog input2	Comment	Setting range for limit value: (can be restricted via the setup)	Limits for Underrange / overrange
Pt100 DIN EN 60751	In 3-wire circuit IEC 60751:2008	-1999 to +9999 °C	-205 °C/ +855 °C
Pt1000 DIN EN 60751	In 3-wire circuit IEC 60751:2008	-1999 to +9999 °C	-205 °C/ +855 °C
Pt100 DIN EN 60751	in 2-wire circuit IEC 60751:2008	-1999 to +9999 °C	-205 °C/ +855 °C
Pt1000 DIN EN 60751	in 2-wire circuit IEC 60751:2008	-1999 to +9999 °C	-205 °C/ +855 °C
W3Re-W25Re "D"	Thermocouple ASTM E1751M-09 (bis 2315 °C): 2009	-1999 to +9999 °C	-5 to +2500 °C
W5Re-W26Re „C“	Thermocouple ASTM E230M-11: 2011	-1999 ... +9999°C	-5 ... +2320°C
Cu-CuNi "T"	Thermocouple DIN EN 60584-1: 1996-10	-1999 to +9999 °C	-205 to +405 °C
Fe-CuNi "J"	Thermocouple DIN EN 60584-1: 1996-10	-1999 to +9999 °C	-205 to +1205 °C
Cu-CuNi "U"	Thermocouple DIN 43710: 1985-12	-1999 to +9999 °C	-205 to +605 °C
Fe-CuNi "L"	Thermocouple DIN 43710: 1985-12	-1999 to +9999 °C	-205 to +905 °C
NiCr-Ni "K"	Thermocouple DIN EN 60584-1: 1996-10	-1999 to +9999 °C	-205 to +1377 °C
Pt10Rh-Pt "S"	Thermocouple DIN EN 60584-1: 1996-10	-1999 to +9999 °C	-55 to +1773 °C
Pt13Rh-Pt "R"	Thermocouple DIN EN 60584-1: 1996-10	-1999 to +9999 °C	-55 to +1773 °C

7.2.8 Sensor type 2 For analog input2	Comment	Setting range for limit value: (can be restricted via the setup)	Limits for Underrange / overrange
Pt30Rh-Pt6Rh "B"	Thermocouple DIN EN 60584-1: 1996-10	-1999 to +9999 °C	295 to 1825 °C
NiCrSi-NiSi "N"	Thermocouple DIN EN 60584-1: 1996-10	-1999 to +9999 °C	-105 to +1305 °C
4 to 20 mA	Standard signal	-1999 to +9999 °C	3.6 to 21 mA

■ Factory setting

Parameter	Comment	Value range (factory-setting in bold)
7.2.9 Offset 2	Using Offset2, a measured value at the analog input can be corrected by the value entered over the total measuring range.	-999.9 to 0.0 to 999.9
7.2.10 Lead wire resistance 2 (resistivity)	Lead wire resistance analog input 2 in 2-wire circuit This value is used to compensate the resistance of the probe line and depends on the line length. Enter the ohmic resistance of the probe line here to achieve the best possible temperature measurement.	0.0 to 30.0 ohm

Parameter	Comment	Value range (factory-setting in bold)
7.2.11 Filter time 2	<p>Time constant of the digital input filter 2nd order for analog input 2</p> <p>If the input signal changes suddenly, approx. 26 % of the change is recorded following a period that corresponds to the filter time constant dF ($2 \times dF$: approx. 59 %; $5 \times dF$: approx. 96 %). Value 0 means: filter switched off</p> <p>If the filter time is long:</p> <ul style="list-style-type: none"> - Interfering signals are better absorbed - Measured value display responds more slowly to changes 	0.0 to 0.6 to 100 sec.
7.2.12 Scaling start 2	<p>Important information: This setting only occurs if the sensor type 2 was set to 4 to 20mA!</p> <p>Here, the user selects which value (i.e. pressure) should be displayed at 4 mA.</p>	-9999 to 0 to 9999
7.2.13 Scaling end 2	<p>Here, the user selects which value (i.e. pressure) should be displayed at 20 mA.</p>	-9999 to 100 to 9999

7.3 Limiter/monitor

Parameter	Comment	Value range (factory-setting in bold)
7.3.1 Device function	<p>Safety temperature limiter (STB) initial startup: Regardless of the switching status of the alarm relay output prior to power failure, the STB remains locked when power returns.</p> <p>The purpose of this factory setting is to ensure that the device will be in a safe switched-off state when the voltage supply is switched on for the first time. After this initial startup, the device function can be set to STB or STW.</p> <p>Safety temperature limiter STB: The device must be manually reset using the keypad or the binary input as soon as the main measured value is back within the valid range.</p> <p>Safety temperature monitor STW: The device is automatically reset as soon as the main measured value is back within the valid range.</p>	STB initial startup , STB, STW

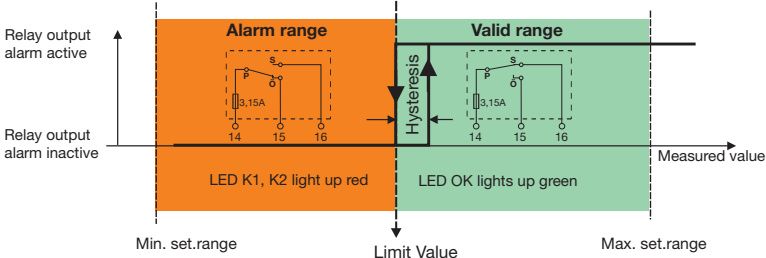
Parameter	Comment	Value range (factory-setting in bold)
7.3.2 Switching behavior	Min. alarm: If the measured value falls below the limit value, the relay output alarm switches to OFF. The LEDs K1 and K2 light up red and the measured values flash in the display.	Max. alarm, min. alarm
<p>Min. alarm (older devices: S-Function)</p>  <p>If set to the safety temperature limiter (STB) setting, this condition remains even when the main measured value is back in the valid range. Only when the "Reset" key is pressed or a switch is activated when the binary input is respectively configured will the alarm relay output switch on again and the OK LED light up green.</p> <p>When setting the safety temperature monitor (STW), the alarm relay output automatically switches back to ON as soon as the main measured value is back within the valid range.</p>		

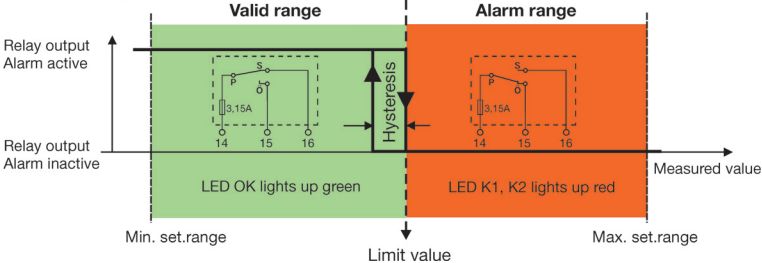
Parameter	Comment	Value range (factory-setting in bold)
	<p>Max. alarm: If the measured value exceeds the limit value, the relay output alarm switches OFF. The LEDs K1 and K2 light up red and the measured values flash in the display.</p>	
<p>Max. alarm (older devices: O-Function)</p>	 <p>The graph illustrates the 'Max. alarm' function. The horizontal axis represents the 'Measured value', divided into three regions: 'Valid range' (green background), 'Limit value' (indicated by a vertical dashed line), and 'Alarm range' (orange background). The 'Valid range' is bounded by 'Min. set.range' and 'Limit value'. The 'Alarm range' is bounded by 'Limit value' and 'Max. set.range'. A 'Hysteresis' zone is shown as a vertical band between the 'Limit value' and the 'Valid range' boundary. The vertical axis shows 'Relay output Alarm active' (top) and 'Relay output Alarm inactive' (bottom). Two circuit diagrams are shown: one for the 'Valid range' and one for the 'Alarm range'. Both diagrams show a relay coil (3.15A) connected to terminals 14, 15, and 16, with a switch 'S' and a diode 'D'. In the 'Valid range', the relay is active (switch closed). In the 'Alarm range', the relay is inactive (switch open). Below the graph, it is noted that 'LED OK lights up green' in the valid range and 'LED K1, K2 lights up red' in the alarm range.</p>	<p>If set to the safety temperature limiter (STB) setting, this condition remains even when the main measured value is back in the valid range. Only when the "Reset" key is pressed or a switch is activated when the binary input is respectively configured will the alarm relay output switch on again and the OK LED light up green. When setting the safety temperature monitor (STW), the alarm relay output automatically switches back to ON as soon as the main measured value is back within the valid range.</p>

Parameter	Comment	Value range (factory-setting in bold)
7.3.3 Limit value, hysteresis	Limit value alarm: If this value is exceeded or not reached, this affects the alarm relay output depending on the switching behavior.	-200 to 0 to 850 Depends on setting range min. and max.
	Hysteresis limit value: Difference between the switch-off and switch-on threshold, e.g. for rising and falling temperatures.	0 to 2 to 100
7.3.4 Pre-alarm function  The pre-alarm responds according to its setting to the main measured value	No function Pre-alarm relay output is inactive	No function, Absolute value, Limit val. dist. Absolute value inverse Gap limit value inverse Window Window inverse
Absolute value: Pre-alarm relay output is triggered if the value for the pre-alarm is exceeded.	Limit val. dist. Here, the set value for the pre-alarm is used on a basis that is relative to the limit value. If, for example, a pre-alarm of 10 K is entered, the pre-alarm relay output always switches at 10 K before the limit value, regardless of how the limit value is set.	

Parameter	Comment	Value range (factory-setting in bold)
<p>Switching behavior of the relay output pre-alarm for the Min-Alarm setting</p> <p>Min. alarm (older devices: S-Function)</p> <p>The diagrams illustrate the switching behavior of the relay output pre-alarm for the Min-Alarm setting. The top diagram shows a yellow region where the LED KV lights up yellow, indicating the relay output pre-alarm is active. The middle diagram shows an orange region where LED K1, K2 light up red (Alarm range) and a green region where LED OK lights up green (Valid range), with a Limit Value between them. The bottom diagram shows a yellow region where the LED KV lights up yellow, indicating the relay output pre-alarm is active, with an absolute value for the pre-alarm.</p> <p>Value for pre-alarm: Limit value distance</p> <p>Value for pre-alarm: Absolute value e.g. 80°C</p>		

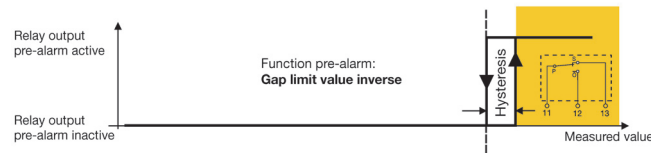
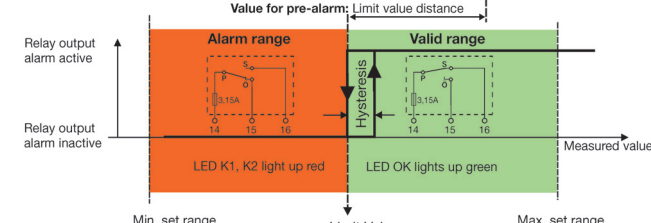
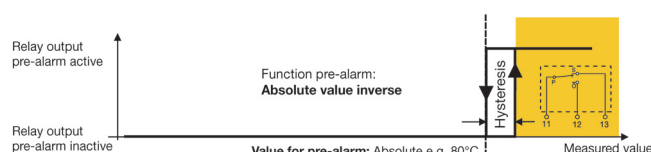

Parameter	Comment	Value range (factory-setting in bold)
Switching behavior of the relay output pre-alarm for the Max-Alarm setting		
Max. alarm (older devices: O-Function)		
<p>Relay output pre-alarm active</p> <p>Relay output pre-alarm inactive</p> <p>LED KV lights up yellow</p> <p>Function pre-alarm: Limit value distance</p> <p>Hysteresis</p> <p>Measured value</p>		
<p>Relay output Alarm active</p> <p>Relay output Alarm inactive</p> <p>Valid range</p> <p>Alarm range</p> <p>LED OK lights up green</p> <p>LED K1, K2 lights up red</p> <p>Hysteresis</p> <p>Value for pre-alarm</p> <p>Limit value distance</p> <p>Min. set.range</p> <p>Limit value</p> <p>Max. set.range</p> <p>Measured value</p>		
<p>Relay output pre-alarm active</p> <p>Relay output pre-alarm inactive</p> <p>LED KV lights up yellow</p> <p>Function pre-alarm: Absolute value</p> <p>Hysteresis</p> <p>Value for pre-alarm: Absolute value e.g. 80°C</p> <p>Measured value</p>		

Parameter	Comment	Value range (factory-setting in bold)
<p>The behavior of the relay output pre-alarm depends on the setting Min-Alarm or Max-Alarm.</p>	<p>Absolute value inverse: The pre-alarm possesses inverse switching behavior in comparison to the "Absolute value" setting and becomes active if the value for pre-alarm is exceeded.</p>	
	<p>Gap limit value inverse: Here, the set value for pre-alarm is used as a distance to the limit value. The pre-alarm possesses inverse switching behavior in comparison to the "Limit val. dist." setting.</p>	

Parameter	Comment	Value range (factory-setting in bold)
Switching behavior of the relay output pre-alarm for the Min-Alarm setting		
Min-Alarm (older devices: S-Function)		
 <p>Relay output pre-alarm active</p> <p>Relay output pre-alarm inactive</p> <p>Function pre-alarm: Gap limit value inverse</p> <p>Hysteresis</p> <p>Measured value</p>		
 <p>Relay output alarm active</p> <p>Relay output alarm inactive</p> <p>Value for pre-alarm: Limit value distance</p> <p>Alarm range</p> <p>Valid range</p> <p>LED K1, K2 light up red</p> <p>LED OK lights up green</p> <p>Min. set.range</p> <p>Limit Value</p> <p>Max. set.range</p> <p>Hysteresis</p> <p>Measured value</p>		
 <p>Relay output pre-alarm active</p> <p>Relay output pre-alarm inactive</p> <p>Function pre-alarm: Absolute value inverse</p> <p>Hysteresis</p> <p>Measured value</p> <p>Value for pre-alarm: Absolute e.g. 80°C</p>		

Parameter	Comment	Value range (factory-setting in bold)
Switching behavior of the relay output pre-alarm for the Max-Alarm setting		
<p>Max. alarm (older devices: O-Function)</p>		
<p>Relay output pre-alarm active</p> <p>LED KV lights up yellow</p> <p>Relay output pre-alarm inactive</p> <p>Function pre-alarm: Gap limit value inverse</p> <p>Hysteresis</p> <p>Measured value</p>		
<p>Relay output Alarm active</p> <p>Valid range</p> <p>Alarm range</p> <p>Relay output Alarm inactive</p> <p>LED OK lights up green</p> <p>LED K1, K2 lights up red</p> <p>Measured value</p> <p>Min. set.range</p> <p>Limit value</p> <p>Max. set.range</p> <p>Hysteresis</p> <p>Value for pre-alarm: Limit value distance</p> <p>Function pre-alarm: Absolute value inverse</p>		
<p>Relay output pre-alarm active</p> <p>LED KV lights up yellow</p> <p>Relay output pre-alarm inactive</p> <p>Function pre-alarm: Absolute value e.g. 80°C</p> <p>Hysteresis</p> <p>Measured value</p> <p>Value for pre-alarm: Absolute value e.g. 80°C</p>		

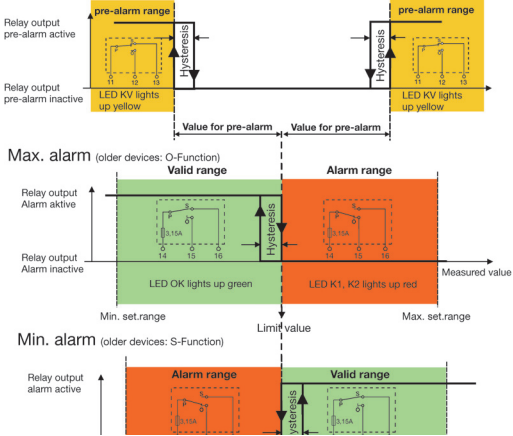
Parameter	Comment	Value range (factory-setting in bold>)
	<p>Window:</p> <p>The set pre-alarm value determines the window width symmetrically around the limit value. Here it is irrelevant if Min-Alarm or Max-Alarm is set.</p>	
<p>In a window symmetrically around the limit value the pre-alarm relay is active.</p>		
<p>The diagrams illustrate the alarm logic based on the measured value relative to the limit value and set ranges.</p> <ul style="list-style-type: none"> Pre-alarm window: Shows a yellow shaded region symmetrically around the limit value. The width is determined by the 'Value for pre-alarm'. The relay output is active (up) within this window, and the LED KV lights up yellow. Hysteresis is shown as a dashed box within the window. Max. alarm (older devices: O-Function): Shows a green 'Valid range' (LED OK lights up green) and an orange 'Alarm range' (LED K1, K2 lights up red). The alarm is active (up) when the measured value is in the alarm range. Hysteresis is shown between the ranges. The limit value is at the boundary between the valid range and the alarm range. Min. alarm (older devices: S-Function): Shows an orange 'Alarm range' (LED K1, K2 lights up red) and a green 'Valid range' (LED OK lights up green). The alarm is active (up) when the measured value is in the alarm range. Hysteresis is shown between the ranges. The limit value is at the boundary between the alarm range and the valid range. <p>Common labels across diagrams include: Relay output (alarm active/inactive), Measured value, Limit value, Min. set.range, and Max. set.range.</p>		

Parameter	Comment	Value range (factory-setting in bold)
	<p>Window inverse:</p> <p>The pre-alarm possesses inverse switching behavior in comparison to the “Window“.</p>	
<p>In a window symmetrically around the limit value the pre-alarm relay is inactive.</p> 	<p>Caution</p> <p>The pre-alarm function is not part of the safety function!</p>	
		

Parameter	Comment	Value range (factory-setting in bold)
7.3.5 Pre-alarm, hysteresis	Pre-alarm The value that triggers the pre-alarm relay output as an absolute value or relative to the limit value.	-9999 to 0 to 9999
	Pre-alarm hysteresis: Difference between the switch-off and switch-on threshold, e.g. for rising and falling temperatures.	0 to 2 to 100
7.3.6 Error Pre-alarm, Relay pre-alarm	Error pre-alarm: Here the user can define to which errors the pre-alarm should react. - Sensor error: see Chapter 8.5 "Measuring circuit monitoring" - Sens.error&diff.: same as sensor error above with additional errors of differential monitoring. - All errors: additional device errors see Chapter 11.	Sensor error Sens.error&diff. All errors
	Relay pre-alarm: Here the user can set which condition the relay output pre-alarm should have when the errors above occur.	Active Inactive
7.3.7 Limit value difference, hysteresis	Limit value difference monitoring: If the value of the temperature difference of the analog input 1-2 is exceeded, the alarm relay output is switched.	0 to 50 to 100
	Hysteresis difference monitoring: Difference between the switch-off and switch-on threshold, e.g. for rising and falling differential values.	0 to 2 to 100
Important information: If, for example, temperature differences arise as a result of the spatial arrangement of a dual probe, an alarm may be triggered by the concurrency monitoring even though the temperature being monitored has not yet been exceeded. In this case, the difference monitoring limit value can be adjusted accordingly.		

Parameter	Comment	Value range (factory-setting in bold)
<p>7.3.8 Setting range min. (formerly ALHI)</p> <p>This is the lower limit of the setting range for the limit value.</p>	<p>This value may not be lower than the lower end of the connected probe or unit signal measuring range. It may also not be set higher than the setting for the alarm limit value.</p>	<p>-9999 to -200 to limit value °C</p>
<p>7.3.9 Setting range max. (formerly ALLO)</p> <p>This is the upper limit of the setting range for the limit value.</p>	<p>This value may not be greater than the higher end of the connected probe or unit signal measuring range. It may also not be set lower than the setting for the alarm limit value.</p>	<p>Limit value to 850 to 9999 °C</p>

The admissible limits for DIN authorized probes:

- ⇒ Chapter 8.11 “Note for suitable probes” and
- ⇒ Chapter 8.12 “Probes for the operating medium air”

7.4 Binary input

Parameter	Comment	Value range (factory-setting in bold)
7.4.1 Function	This sets the function that should be controlled by the binary input.	
	The binary input does not have a function	No function
	The binary input performs a reset as described in Chapter 7.3.1 "Device function". The function only responds to the switching edge from "open" to "closed" state.	Unlocking
	Protection against unauthorized key operation	Key lock
	Configuration level is locked.	Level lock

7.5 Analog output

Parameter	Comment	Value range (factory-setting in bold)
7.5.1 Function	Here, the measured value that is to be shown at the analog output is set.	Main measured value Measured value1 Measured value2 Difference
	Main measured value: With the max-alarm switching behavior, the greater of the two measured values is shown; with the min-alarm, the lower of the two measured values is shown.	
	Measured value1: Measured value of analog input 1 (E1) is shown	
	Measured value2: Measured value of analog input 2 (E2) is shown	
	Difference: E1-E2 is shown The signal that should be output by the analog output can be set with scaling start and end.	
7.5.2 Signal type	4 to 20 mA	4 to 20 mA, 0 to 20 mA 2 to 10 V 0 to 10 V
	0 to 20 mA	
	2 to 10 V	
	0 to 10 V	
7.5.3 Scaling start	⇒ Picture in Chapter 7.5.7	-9999 to -200 to 9999
7.5.4 Scaling end	⇒ Picture in Chapter 7.5.7	-9999 to 800 to 9999

Parameter	Comment	Value range (factory-setting in bold)
7.5.5 Error cases	<p>Various error cases can be configured for the analog output, to put out the configured error signal.</p> <p>Sensor error 2x means: The analog output gives an error signal, regardless of which sensor is faulty. Exception: if the main measured value is set in Chapter 7.5.1 both sensors must be faulty for the error signal to be output. The measured value of the sensor that is OK is put out.</p> <p>Sensor error 1x means: If there is a sensor error of the corresponding channel (see analog output Function) is present the analog output puts out an error signal.</p> <p>Sensor error & diff. means: If there is a sensor error of the corresponding channel (see analog output Function) is present or if the limit value Difference is exceeded (independent of the parameter "Analog output function"), the analog output puts out an error signal.</p> <p>All errors means: In the event of sensor faults, exceeding of the limit value for differential monitoring or internal device errors, a so-called error signal is output at the analog output.</p>	<p>Sensor error 2x Sensor error 1x Sens.err. & diff. All Errors</p>
7.5.6 Error signal	<p>If, for the measured value 1 or 2, the value is exceeded, not reached, or a diagnostic error occurs, the current or voltage value set on the analog output is output as a so-called error signal.</p>	
	<p>For signal type 4 to 20 mA</p>	3.4 or 21.2 mA
	<p>For signal type 0 to 20 mA</p>	0 or 21.2 mA
	<p>For signal type 2 to 10 V</p>	1.7 or 10.4 V
	<p>For signal type 0 to 10 V</p>	0 or 10.4 V

7.5.7 Behavior when leaving the scaling range

The standard signal range of the analog output is limited as follows according to recommendation of Namur NE 43:

Signal type	Lower limit	Upper limit
0: 4 to 20 mA	3.8 mA	20.5 mA
1: 0 to 20 mA	0 mA	20.5 mA
2: 2 to 10 V	1.8 V	10.2 V
3: 0 to 10 V	0 V	10.2 V

■ Factory setting

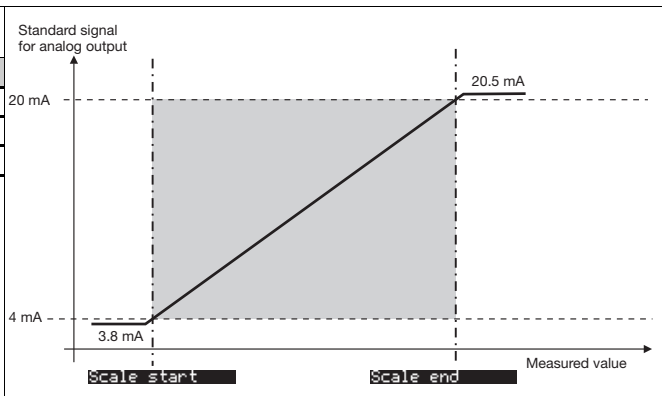

Caution

The analog output is **not part of the safety function!**

7.6 Display/operation

Parameter	Comment	Value range (factory-setting in bold)
7.6.1 Language	German	German , English, French
	English	
	French	
7.6.2 Unit  When the measurement unit changes to °F, the measured value is converted. All other values referring to the measured value (e.g. limit value) remain in their value!	Here a unit for the measured value can be assigned.	°C, °F, %, text
	°C	
	°F	
	%	
	Text: Via the setup program, 2 characters can be entered here for another unit, e.g. Pa (Pascal).	
7.6.3 Decimal place	No decimal place	No decimal place , One decimal place
	One decimal place	
7.6.4 Normal display	This sets the view that appears after the voltage supply is switched on. ⇒ Chapter "Operating overview"	Main measured value , measured values, limit value, pre-alarm, difference
	Main measured value	
	Measured values	
	Limit value	
	Pre-alarm	
	Difference	

Parameter	Comment	Value range (factory-setting in bold)
7.6.5 Contrast	Screen contrast Difference in brightness between black and white pixels	0 to 5 to 10
7.6.6 Lighting	Here the background lighting of the display is set.	Off, On , During operation
	Off: Always switched off	
	On: Always switched on	
	During operation: The background illumination is only switched on when the keys are operated and it lights up until the time for the time-out light has expired.	
7.6.7 Time-out light	Here a waiting period for the switch-off of the background lighting is set.	0 to 30 to 100 sec
7.6.8 Time-out operation	Here, the waiting period is set for the return from the configuration to normal display.	0 to 30 to 100 sec
7.6.9 Code	<p>To protect against unauthorized manipulations, a code can be set here for locking the configuration level. 0 means: code request switched off</p> <p> If the code is forgotten, a new code can be transferred to the device via the setup program.</p> <p>⇒ Chapter 9.3 "Forgotten the code?"</p>	0 to 9999

7.7 Service

Parameter	Comment	Value range (factory-setting in bold)
7.7.1 Limit switching cycle	Limit value for relay switching cycles Here, the limit value for the admissible relay switching cycles is set. If the counter value for Current switching cycles is greater than this value, the display values flash and the alarm relay output secedes. If "0" is set the function is inactive.	0 to 99999
7.7.2 Current switching cycles	Relay switching cycle counter Here, the switching cycles for the relay are only counted if the top limit value for relay switching cycles is not set to "0" and is thus inactive. The value can then be adjusted as required and therefore adapted accordingly to the plant. The switching cycle counter remains at 99999.	0 to 99999
7.7.3 Operating hours	Operating hour counter The counter adds up the operating hours during which the device was connected to the voltage supply. The value cannot be changed and can be used as a measure of how long the device was actually in operation after leaving the plant.	0 to 99999

8 Technical data

8.1 Analog inputs

RTD temperature probe

Designation	Measuring range	Accuracy 2/3-wire circuit ¹	Ambient temperature influence
Pt100 IEC 60751:2008	-200 to +850 °C	0.5% / 0.1%	50 ppm/K
Pt1000 IEC 60751:2008	-200 to +850 °C	0.5% / 0.1%	50 ppm/K
Connection type	Maximum lead wire resistance: 2-wire 15 Ω , 3-wire circuit 30 Ω		
Measuring rate	210 ms		
Error tolerance time	≤ 5s time taken into account for all diagnosis tests		
Input filter	Digital filter, 2nd priority; filter constant can be set from 0 to 100 s		
Special features	Individual probe Pt100 2-wire, display can also be programmed in °F		

Thermocouples

Designation	Measuring range	Accuracy ¹	Ambient temperature influence
Fe-CuNi "L" DIN 43710:1985-12	-200 to +900 °C	0.4%	100 ppm/K
Fe-CuNi "J" DIN EN 60584-1:1996-10	-200 to +1200 °C	0.4%	100 ppm/K

Cu-CuNi "U" DIN 43710:1985-12	-200 to +600 °C	0.4%	100 ppm/K
Cu-CuNi "T" DIN EN 60584-1:1996-10	-200 to +400 °C	0.4%	100 ppm/K
NiCr-Ni "K" DIN EN 60584-1:1996-10	-200 to +1372 °C	0.4%	100 ppm/K
Pt10Rh-Pt "S" DIN EN 60584-1:1996-10	-50 to +1768 °C	0.4%	100 ppm/K
Pt13Rh-Pt "R" DIN EN 60584-1:1996-10	-50 to +1768 °C	0.4%	100 ppm/K
Pt30Rh-Pt6Rh "B" DIN EN 60584-1: 1996-10	0 to 1820 °C	0.4 ² %	100 ppm/K
NiCrSi-NiSi "N" DIN EN 60584-1: 1996-10	-100 to +1300 °C	0.4 ² %	100 ppm/K
W3Re-W25Re "D" ASTM E1751M-09 (bis 2315 °C): 2009	0 to 2495 °C	0.4%	100 ppm/K
W5Re-W26Re „C“ ASTM E230M-11: 2011	0 to 2315 °C	0.4%	100 ppm/K
Cold junction	Pt100 internal		
Cold junction accuracy	± 1 K		
Measuring rate	210 ms		
Error tolerance time	≤ 5 s time taken into account for all diagnosis tests		
Input filter	Digital filter, 2nd priority; filter constant can be set from 0 to 100 s		

- 1.The accuracy values refer to the maximum measuring range.
- 2.The accuracy is only guaranteed above a temperature of 300° C

Direct current

Measuring range	Accuracy	Ambient temperature influence
4 to 20 mA, voltage drop < 2 V	0.2 %	150 ppm/K
Scaling	Can be freely programmed within the limits	
Measuring rate	210 ms	
Error tolerance time	≤ 5 s time taken into account for all diagnosis tests	
Input filter	Digital filter, 2nd priority; filter constant can be set from 0 to 100 s	
Special features	Individual probe 4 to 20 mA	

8.2 Analog output

	Type of signal	Accuracy	Residual ripple	Load influence	Temperature influence	Load resistance
Current	4 to 20 mA	≤ 0.5 %	± 0.5 % at 300 Ω	± 0.05 mA/ 100 Ω	150 ppm / K	≤ 500 Ω
	0 to 20 mA					
Voltage	2 to 10 V	≤ 0.5 %	± 0.5 %	± 15 mV	150 ppm / K	≥ 500 Ω
	0 to 10 V					

8.3 Binary input

Connection	Function
1 potential-free contact	Unlocking, keyboard locking, level locking can be configured

8.4 Relay outputs

Relay output KV	Relay (changeover contact) without shroud 30000 operations at a performance of 3 A /250 V, 50 Hz resistive load or maximum DC 30 V / 3 A. Minimal current: DC 12 V / 100 mA.
Relay output alarm	Changeover contact Contact protection switching: safety fuse 3.15 AT, installed in the Pole contact arm 30000 operations at a performance of 3 A /230 V, 50 Hz resistive load or maximum DC 30 V / 3 A. Minimal current: DC 12 V / 100 mA.

8.5 Measuring circuit monitoring

	RTD temperature probe in three-wire circuit and double thermocouples	Thermocouples	Current 4 to 20mA
Overrange and underrange	Is detected LED K1, K2, KD and KV are lit; ">>>>" flashes in the display for overrange, "<<<<" for underrange.		
Probe and wire break	Is detected LED K1, K2, KD and KV are lit; ">>>>" flashes in the display; relay output "Alarm" is inactive		LED K1, K2, KD and KV are lit; ">>>>" flashes in the display; relay output "Alarm" is inactive
Probe short-circuit	Is detected LED K1, K2, KD and KV are lit; "<<<<" flashes in the display; relay output "Alarm" is inactive	Is detected by difference monitoring of the analog inputs ⇒ Chapter 7.3.7 "Limit value difference, hysteresis"	LED K1, K2, KD and KV are lit; "<<<<" flashes in the display; relay output "Alarm" is inactive

8.6 Voltage supply

Voltage supply	AC/DC 20 to 30 V, 48 to 63 Hz	AC 110 to 240 V, +10/-15 %, 48 to 63 Hz
Power consumption, Power loss	max. 12 W	max. 12 W
Power consumption, Power loss for the following mode: Analog output 10mA; background lighting Display off; Relay output "Alarm" on; Relay output pre-alarm off; Sensor: 2xPt100	5 W	5 W

8.7 Test voltages according to EN 60730, part 1

Input and output against voltage supply	
- At a voltage supply AC 110 to 240 V +10 % /-15 %	3.7 kV/50 Hz
- At a voltage supply AC/DC 20 to 30 V, 48 to 63 Hz	3.7kV/50 Hz

8.8 Electrical safety

	Clearances / creep paths
Mains to electronic components and probes	$\geq 6 \text{ mm} / \geq 8 \text{ mm}$
Mains to relays	$\geq 6 \text{ mm} / \geq 8 \text{ mm}$
Relays to electronic components and probes	$\geq 6 \text{ mm} / \geq 8 \text{ mm}$
Electrical safety	According to DIN EN 14597 (DIN EN 60730-2-9) Overvoltage category III, pollution degree 2
Protection rating I	With internal separation from SELV current circuits

8.9 Environmental influences

Ambient temperature range	0 to. +55 °C
Storage temperature range	-30 to +70 °C
Site altitude	maximum 2000 m above MSL
Temperature influence	$\leq \pm 0.005 \% / \text{K dev. from } 23 \text{ }^\circ\text{C}^1$ for RTD temperature probes
	$\leq \pm 0.015 \% / \text{K dev. from } 23 \text{ }^\circ\text{C}^1$ for thermocouples and current

Terminal temperature Range	If the temperature range of -10 °C to +80 °C is exceeded or undercut, the device shows the error message "Terminal temperature Range". The output changes to a safe state (quiescent current principle). The message can only be acknowledged, if the temperature is back again in the valid range.
Environmental performance	85 % rel. humidity without condensation (3K3 with extended temperature range according to DIN EN 60721-3-3)
EMC	According to DIN EN 14597 and standards from the standard series DIN EN 61326
Emitted interference	Class B
Interference resistance	Evaluation criteria FS according to DIN EN 14597, regulation and control devices (RS)

1. All specifications refer to the measuring range limit value

8.10 Case

Material	Polycarbonate
Flammability class	UL 94 V0
Electrical connection	On the front via screw terminals up to max. 2.5 mm ²
Installation	On 35 mm DIN rail according to EN 60715
Installation position	vertical
Weight	Approx. 230 g
Protection class	IP 20 according to DIN EN 60529

8.11 Note for suitable probes

The probes in data sheet 901006, 902006 and probes with JUMO manufacturer's declaration can be connected.
The installation instructions for probes must be observed.

8.12 Probes for the operating medium air

Note: Due to the response accuracy, use **is only permitted without pockets** (thermowells).

Actual type designation	Probe type	Temperature range	Nom. length mm	Process connection
RTD temperature probe Data Sheet 902006				
902006/65-228-1003-1-15-500-668/000	1 x Pt100	-170 ... +700°C	500	Stop flange movable
902006/65-228-1003-1-15-710-668/000			710	
902006/65-228-1003-1-15-1000-668/000			1000	
902006/55-228-1003-1-15-500-254/000	1 x Pt100	-170 ... +700°C	500	movable G1/2 compression clamp
902006/55-228-1003-1-15-710-254/000			710	
902006/55-228-1003-1-15-1000-254/000			1000	
902006/65-228-2003-1-15-500-668/000	2 x Pt100	-170 ... +700°C	500	Stop flange movable
902006/65-228-2003-1-15-710-668/000			710	
902006/65-228-2003-1-15-1000-668/000			1000	
902006/55-228-2003-1-15-500-254/000	2 x Pt100	-170 ... +700°C	500	movable G1/2 compression clamp
902006/55-228-2003-1-15-710-254/000			710	
902006/55-228-2003-1-15-1000-254/000			1000	
Thermocouples Data Sheet 901006				
901006/65-547-2043-15-500-668/000	2 x NiCr-Ni, Typ „K“	-35 ... +800°C	500	Stop flange movable
901006/65-547-2043-15-710-668/000			710	
901006/65-547-2043-15-1000-668/000			1000	

901006/65-546-2042-15-500-668/000	2 x Fe-CuNi, Typ „L“	-35 ... +700°C	500	Stop flange movable
901006/65-546-2042-15-710-668/000			710	
901006/65-546-2042-15-1000-668/000			1000	
901006/66-550-2043-6-500-668/000	2 x NiCr-Ni, Typ „K“	-35 ... +1000°C	500	Stop flange movable
901006/66-550-2043-6-355-668/000			355	
901006/66-550-2043-6-250-668/000			250	
901006/66-880-1044-6-250-668/000	1 x PT10Rh-PT, Typ „S“	0 ... 1300°C	250	Stop flange movable
901006/66-880-1044-6-355-668/000			355	
901006/66-880-1044-6-500-668/000			500	
901006/66-880-2044-6-250-668/000	2 x PT10Rh-PT, Typ „S“	0 ... 1300°C	250	Stop flange movable
901006/66-880-2044-6-355-668/000			355	
901006/66-880-2044-6-500-668/000			500	
901006/66-953-1046-6-250-668/000	1 x PT30Rh-PT6Rh, Typ „B“	600 ... 1500°C	250	Stop flange movable
901006/66-953-1046-6-355-668/000			355	
901006/66-953-1046-6-500-668/000			500	
901006/66-953-2046-6-250-668/000	2 x PT30Rh-PT6Rh, Typ „B“	600 ... 1500°C	250	Stop flange movable
901006/66-953-2046-6-355-668/000			355	
901006/66-953-2046-6-500-668/000			500	

8.13 Probes for water and oil

Note: Due to the response accuracy, use **is only permitted without pockets** (thermowells).

Actual type designation	Probe type	Temperature range	Nom. length mm	Process connection
RTD temperature probe Data Sheet 902006				
902006/10-402-1003-1-9-100-104/000	1 x Pt100	-40 ... +400°C	100	G1/2 compression clamp
902006/10-402-2003-1-9-100-104/000	2 x Pt100		100	
902006/54-227-2003-1-15-710-254/000	2 x Pt100	-170 ... 550°C	65...670	movable G1/2 compression clamp
902006/54-227-1003-1-15-710-254/000	1 x Pt100		65...670	
902006/10-226-1003-1-9-250-104/000	1 x Pt100	-170 ... 480°C	250	G1/2 compression clamp
902006/10-226-2003-1-9-250-104/000	2 x Pt100		250	
902006/10-402-1003-1-9-100-104/000	1 x Pt100	-40 ... +400°C	100	G1/2 compression clamp
902006/10-402-2003-1-9-100-104/000	2 x Pt100		100	G1/2 compression clamp
902006/10-402-1003-1-9-150-104/000	1 x Pt100		150	G1/2 compression clamp
902006/10-402-2003-1-9-150-104/000	2 x Pt100		150	G1/2 compression clamp
902006/10-402-1003-1-9-200-104/000	1 x Pt100		200	G1/2 compression clamp
902006/10-402-2003-1-9-200-104/000	2 x Pt100		200	G1/2 compression clamp
Thermocouples Data Sheet 901006				
901006/54-544-2043-15-710-254/000	2 x NiCr-Ni, Typ „K“	-35 ... 550°C	65...670	movable G1/2 compression clamp
901006/54-544-1043-15-710-254/000	1 x NiCr-Ni, Typ „K“		65...670	
901006/54-544-2042-15-710-254/000	2 x FeCuNi, Typ „L“		65...670	
901006/54-544-1042-15-710-254/000	1 x FeCuNi, Typ „L“		65...670	

Note:

Due to the response accuracy, use is **only permitted with thermowells** (immersion sleeves) **supplied by the factory..**

Actual type designation	Probe type	Temperature range	Nom. length mm	Process connection
RTD temperature probe Data Sheet 902006				
902006/53-505-2003-1-12-190-815/000	2 x Pt100	-40 ... +400 °C	190	welding sleeve
902006/53-507-2003-1-12-100-815/000	(arranged one below the other in the protection tube)	-40 ... +480 °C	100	welding sleeve
902006/53-507-2003-1-12-160-815/000			160	
902006/53-507-2003-1-12-190-815/000			190	
902006/53-507-2003-1-12-220-815/000			220	
902006/53-507-1003-1-12-100-815/000	1 x Pt100	-40 ... +480 °C	100	welding sleeve
902006/53-507-1003-1-12-160-815/000			160	
902006/53-507-1003-1-12-220-815/000			220	
902006/53-505-1003-1-12-190-815/000	1 x Pt100	-40 ... +400 °C	190	welding sleeve
902006/53-505-3003-1-12-100-815/000	3 x Pt100	-40 ... +400 °C	100	welding sleeve
902006/53-505-3003-1-12-160-815/000			160	
902006/53-505-3003-1-12-220-815/000			220	
902006/40-226-1003-1-12-220-815/000	1 x Pt100	-170 ... +480°C	220	welding sleeve
902006/40-226-1003-1-12-160-815/000			160	
902006/40-226-1003-1-12-100-815/000			100	
Thermocouples Data Sheet 901006				

901006/53-543-1042-12-220-815/000	1 x Fe-CuNi Typ „L“	-35 ... 480°C	220	welding sleeve
901006/53-543-2042-12-220-815/000	2 x Fe-CuNi Typ „L“		220	

8.14 Probes for water, oil and air

Note: Due to the response accuracy, use **is only permitted without pockets** (thermowells).

Actual type designation	Probe type	Temperature range	Install. length mm	Process connection
RTD temperature probe Data Sheet 902006				
902006/10-390-1003-1-8-250-104/000	1 x Pt100	max. 300°C	250	G1/2 compression clamp
Thermocouples Data Sheet 901006				connection line AL in mm
901006/45-551-2043-2-EL-11-AL/000	2 x NiCr-Ni, Typ „K“	max. 1150°C	50...2000	1000...20000



Probe short-circuit is only detectable with a double thermocouple.

9 Setup program

The program and the connection cable are available as accessories and offer the following possibilities:

- Easy and comfortable parameterization and archiving via PC
- Easy parameter duplication for identical types of devices

9.1 Minimum hardware and software prerequisites:

- PC Pentium III or higher
- 128 MB RAM, 16 MB free on hard disk
- CD-ROM drive
- Free USB interface, mouse connection
- Microsoft¹ Windows¹ XP, VISTA, WIN 7 and 8 with 32 or 64bit
- * Connect the device to the PC using the USB cable

9.2 Displaying the device software version

- * Simultaneously press the **P** and **▲** keys and hold down

This version is also recognized by the setup program and displayed under *Info* ⇒ *Information about setup*.

The software versions of the device and the setup program must be compatible as otherwise an error message will appear!

1. Is a registered trademark of Microsoft Corporation

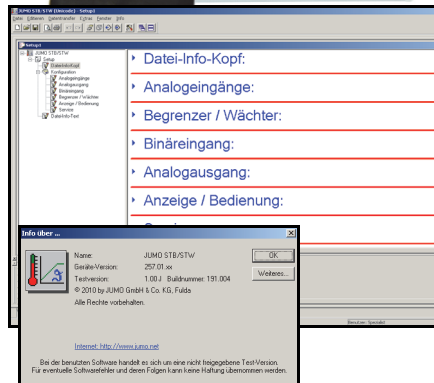
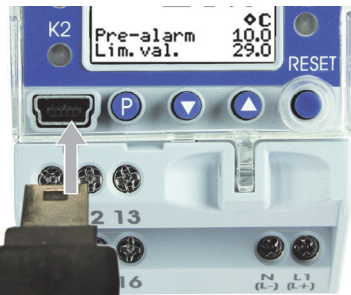

9.3 Forgotten the code?

If you forget the code, it can be read out via the USB interface and the setup program.

* Perform a data transfer \Rightarrow read-out from device.

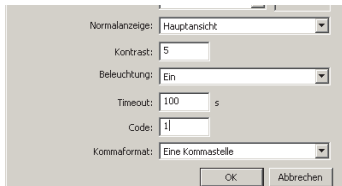

The screenshot shows a configuration window with the following fields and controls:

- Normalanzeige: Hauptansicht (dropdown menu)
- Kontrast: 5 (input field)
- Beleuchtung: Ein (dropdown menu)
- Timeout: 100 s (input field)
- Code: | (input field)
- Kommaformat: Eine Kommastelle (dropdown menu)
- Buttons: OK and Abbrechen



The read-out code now appears in the setup program.

It can be retained or changed.

If "0" is set and transferred to the device, the code interrogation is deactivated and the configuration level is freely accessible.

9.4 Special function: thermocouple reverse polarity protection

If a thermocouple is incorrectly connected (reverse polarity), incorrect measured values will be displayed, e.g. negative temperatures instead of the expected positive temperatures may be displayed.

This may lead to the set limit value never being reached. An additional limit value will be defined that is factory set to $-205\text{ }^{\circ}\text{C}$ and the relay alarm will be triggered if the actual value falls below this limit.

This value must be effectively selected to ensure that a possible reverse polarity is detected.

Verpolungsschutz funktionsfähig wenn $|\theta_0| \geq |\theta_p|$ und $|\theta_0| \geq |\theta_v|$

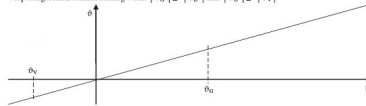

Grenzwert einstellbar: θ_0 -9999°C bis $+9999^{\circ}\text{C}$ z.B. -50°C

Grenzwert Verpolungsschutz einstellbar: θ_v -205°C bis $+200^{\circ}\text{C}$ z.B. 100°C



Grenzwert Differenzmessung einstellbar: θ_p 0°C bis 100°C

Im Falle der asymmetrischen Verpolung der Sensorik, schaltet der STB die Anlage beim Erreichen des Differenzgrenzwertes die Anlage sicher ab.

Im Falle der symmetrischen Verpolung wird dem STB fallende Temperatur auf den redundanten Kanälen signalisiert. Wird der Verpolungsgrenzwert erreicht, schaltet der STB sicher die Anlage ab.

10 Alarm messages

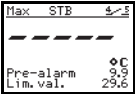
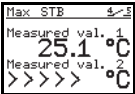
They can appear as follows:

Alarm display	Cause	Remedy
5 flashing horizontal lines: 	Measured value error No valid value can be displayed	<ul style="list-style-type: none"> * Check error messages on the screen * Please contact the JUMO Service department ⇨ Chapter 2.5 "Service addresses"
	Measured value overrange The measured value is too high, is outside the measuring range or the probe is broken.	<ul style="list-style-type: none"> * Change the display to 2 measured values This makes it possible to detect which channel is defective. * Check the probe and connection line for damage or short-circuit.
	Measured value underrange The measured value is too low, is outside the measuring range or a short-circuit occurred at the probe.	<ul style="list-style-type: none"> ⇨ Chapter 4.2 "Connection diagram" * Check that the correct probe is set and/or connected. ⇨ Chapter 7.2 "Analog inputs"
5 flashing asterisks 	Display overflow Value cannot be displayed	<ul style="list-style-type: none"> * Check error messages on the screen * Please contact the JUMO Service department ⇨ Chapter 2.5 "Service addresses"

11 Error messages

These error messages are displayed one below the other.

Error display (Err)	Origin	Cause/remedy
	Internal	The set limit value for relay switching operations has been reached * Increase the limit value for the relay switching operations ⇒ Chapter 7.7.1 "Limit switching cycle" A tick appears in place of the bell and the error message can be acknowledged
Terminal temp.	Internal	The internal Pt100 is defective ¹ , or the terminal temperature has fallen outside the admissible range (-10 to 80 °C). This error cannot be acknowledged until it is within the admissible range again.
Reference volt. ¹	Internal	The reference voltage is outside the valid range. Acknowledgement is not possible until it is within the valid range again.
Calibration const. ¹	Internal	A calibration constant is outside the valid range. Acknowledgement is not possible until it is within the valid range again.
Configuration	Internal	Configuration data outside the value range. Acknowledgement is not possible until it is within the valid range again.
Measured value	Internal	The measured value 1 or 2 is outside the valid range. Acknowledgement is not possible until it is within the valid range again.



Error display (Err)	Origin	Cause/remedy
Measured value missing	Internal	When the error status "Measured value" is signaled by the channel then the diagnosis function tries to show the precise error on the basis of the read measured value.
Probe short-circ.	External	
Meas. range overr.		
Meas. range underr.		
Probe break		
Operating access ¹	Internal	The diagnosis function communicates with the STB/STW. Acknowledgement is not possible until communication has finished.
Setup access	Internal	The setup program is communicating with the STB/STW. Acknowledgement is not possible until communication has finished.
CRC calibr. ¹	Internal	Checksum error of the EEPROM-calibration data. Acknowledgement is not possible until it is within the valid range again.
CRC config. ¹	Internal	Checksum error of the EEPROM-configuration data. Acknowledgement is not possible until it is within the valid range again.
Registry ¹	Internal	A registry error has occurred. Acknowledgement not possible until the error has been remedied.
RAM defective ¹	Internal	A RAM error has occurred. Acknowledgement not possible until the error has been remedied.
ROM defective ¹	Internal	A ROM error has occurred. Acknowledgement is not possible until it is within the valid range again.
Program sequence ¹	Internal	A program sequence error has occurred. Acknowledgement not possible until the error has been remedied.

Error display (Err)	Origin	Cause/remedy
Watchdog ¹	Internal	A watchdog reset has occurred. Acknowledgement is possible.
Overvoltage ¹	Internal	The uncontrolled secondary supply voltage is too high. Acknowledgement is possible.
Frequency ¹	Internal	Error of the independent time base Acknowledgement is possible
EEPROM defective ¹	Internal	Error during internal communication with the EEPROM. Acknowledgement is possible.
Stack ¹	Internal	Error in the memory area reserved for the stack Acknowledgement is not possible until it is within the valid range again.
AD converter ¹	Internal	Error during internal communication with the A/D converter. Acknowledgement is possible
Simulation ¹	Internal	Error during measured value simulation. Acknowledgement is possible.
Zero point ¹	Internal	The zero point voltage of the A/D converter is too low. Acknowledgement is possible.
Limit value	System	The configured limit value has been exceeded or has fallen under.

Error display (Err)	Origin	Cause/remedy
Diagnosis function		
FLASH defective ¹	Internal	An error was detected during the cyclic memory test of the ROM.
RAM defective ¹	Internal	An error was detected during the cyclic memory test of the RAM.
CRC config. ¹	Internal	An error was detected by the checksum test (CRC16) in the configuration of the diagnosis function.
CRC calib. ¹	Internal	An error was detected by the checksum test (CRC16) in the calibration data of the diagnosis function.
Configuration	Internal	The configuration contains invalid data.
SW version ¹	Internal	The software versions are not valid.
Editing	Internal	An error has occurred during editing.
V too low	Internal	The internal voltage supply value has fallen below the permitted range.
V too high	Internal	The permitted range of the internal voltage supply has been exceeded.
Int. communic. ¹	Internal	An error has occurred during internal communication.
No acces to channels	Internal	Communication to one or both channels doesn't work correctly.
Diff.value	System	The difference (channel 1 minus channel 2) of the measured values has exceeded the maximum permitted value.
Switching operations	Internal	The configured limit of the switching operations has been exceeded (there is only one counter as all alarm relays switch).The error can be acknowledged when the current counter is reduced or the limit is increased (so that the switching operations are not accidentally set to 0 in the event of further errors).
USB communic.	Internal	An error has occurred during USB communication.

Error display (Err)	Origin	Cause/remedy
Footnote 1		<p>If the error cannot be acknowledged despite repeated switching off and on, the device must be repaired by JUMO.</p> <ul style="list-style-type: none">* Return the device <p>⇒ Chapter 2.5 "Service addresses"</p>

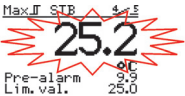
12 What to do, if ...

Description	Cause	Remedy
<p>The following appears in the display:</p> 	<p>Setup program transmits data. The monitoring function switches off briefly during data transmission and the device re-starts.</p>	<ul style="list-style-type: none"> - Wait until data transmission has finished.
<p>The measured value flashes in the top display.</p> 	<p>The device is in the alarm range LEDs K1, K2 are lit red. The measured value flashes in the display and is higher or lower than the limit value depending on the switching behavior set.</p> <ul style="list-style-type: none"> - Measured value too high or too low - Excessive deviation between the temperature values during difference monitoring 	<ul style="list-style-type: none"> * Check the limit value in the configuration level. * Find out the reason for the overrange or under-range. * If necessary, correct the limit value * If necessary, reduce an excessive hysteresis because it might be too high in the OK range. <p>⇒ Chapter 7.7.3 "Operating hours"</p>
<p>LED K1 is lit red, although the measured value is in the OK range</p>	<p>The device is set as a safety temperature limiter (STB). Even if the measured value is already in the OK range after being exceeded, the relay of an automatic reset temperature limiter does not automatically reset. It must be unlocked manually.</p>	<ul style="list-style-type: none"> * Press the  (RESET) key for longer than 3 seconds to manually unlock the relay. <p>⇒ Chapter 5.5 "Alarm acknowledgement using the Reset key (only for temperature limiters STB)"</p>

Description	Cause	Remedy
... relay output "Alarm" between terminal 14 and 16 is not closed although the LED OK is lit green (in the OK range).	- The integrated fuse cut-out is defective, caused by an excessive relay current.	<ul style="list-style-type: none"> * Measure terminal 14 and 16 of the relay when the LED K1 is lit green using a continuity test device. * The device must be returned to JUMO for repair. ⇨ Chapter 2.5 "Service addresses"
... the display is dark, only the LEDs are lit	- Display shut-down after timeout was activated	<ul style="list-style-type: none"> * Press any key or switch off timeout. ⇨ Chapter 7.6.8 "Time-out operation"

13 Information for devices with extra code 062 GL

The following information supplements or replaces the existing information.

13.1 Technical data

Tests carried out

Product(s) approved by this certificate is/are accepted for installation on all vessels classed by DNV.

Location Class:

Temperature B

Humidity B

Vibration A

EMC B

Enclosure A

13.2 Alarm messages

⇒ Chapter 10 "Alarm messages"

13.3 Locks

The configuration level can be inhibited with a code.

⇒ Chapter 7.6.9 "Code"

Intentional or unintentional adjustments are not possible without additional measures.

⇒ Chapter 5.7 "Lead sealing the device"



For service work, the device must be returned to the head office.
According to recommendation of DNV the availability of a replacement device must be guaranteed for certain applications.



We recommend keeping a printout of the configuration parameters (setup program) and the technical documents of the STB/STW (connection diagram) on site (request a copy if necessary).

14 Output behavior

Operating status	Relay output alarm	Relay output pre-alarm KV	Analog output
Initialization			
Initialization phase after mains voltage – ON (for approx. 10 seconds)	Inactive	Inactive	0 mA, 0 V
Setup communication			
During reading-writing of the configuration (for approx. 5 seconds)	Inactive	Pre-alarm monitoring active ⇒ Chapter 7.3.4	Scaled analog signal is being output ⇒ Chapter 7.5
Standard operation			
After initialization phase system is in error-free status (STB - initial startup)	Inactive Unlocking possible	Pre-alarm monitoring active ⇒ Chapter 7.3.4	Scaled analog signal is being output ⇒ Chapter 7.5
After initialization phase system is in error-free status (STB, STW)	Monitoring of the limit value active ⇒ Chapter 7.3.2		
External error			

Operating status	Relay output alarm	Relay output pre-alarm KV	Analog output
Probe break, probe short circuit (e.g. input 1)	Inactive	Error- and relay pre-alarm can be configured ⇒ Chapter 7.3.6	Error cases can be configured ⇒ Chapter 7.5.5 Error signal output ⇒ Chapter 7.5.6
After probe break, probe short circuit (STW)	Monitoring of the limit value active ⇒ Chapter 7.3.2	Pre-alarm monitoring active ⇒ Chapter 7.3.4	Scaled analog signal is being output ⇒ Chapter 7.5
After probe break, probe short circuit (e.g. input 1) (STB)	Inactive Unlocking possible		
After acknowledgement probe break Probe short circuit (STB)	Monitoring of the limit value active ⇒ Chapter 7.3.2		
Difference monitoring through diagnostics			
Differential – Alarm (STW function)	Inactive	Error- and relay pre-alarm can be configured ⇒ Chapter 7.3.6	Error cases can be configured ⇒ Chapter 7.5.5 Error signal output ⇒ Chapter 7.5.6

Operating status	Relay output alarm	Relay output pre-alarm KV	Analog output
Differential – Alarm inactive again (STW function)	Monitoring of the limit value active ⇒ Chapter 7.3.2	Pre-alarm monitoring active ⇒ Chapter 7.3.4	Scaled analog signal is being output ⇒ Chapter 7.5
Differential – Alarm (STB function)	Inactive	Error- and relay pre-alarm can be configured ⇒ Chapter 7.3.6	Error cases can be configured ⇒ Chapter 7.5.5 Error signal output ⇒ Chapter 7.5.6
Differential – Alarm inactive again (STB function)	Inactive Unlocking possible	Pre-alarm monitoring active ⇒ Chapter 7.3.4	Scaled analog signal is being output ⇒ Chapter 7.5
After acknowledgement probe break – Alarm (STB function)	Monitoring of the limit value active ⇒ Chapter 7.3.2		
Internal errors			
Internal errors diagnostic channel active	Inactive	Pre-alarm monitoring active ⇒ Chapter 7.3.4	Scaled analog signal is being output ⇒ Chapter 7.5
Internal errors diagnostic channel inactive again	Monitoring of the limit value active ⇒ Chapter 7.3.2		

Operating status	Relay output alarm	Relay output pre-alarm KV	Analog output
Internal errors safety channel active (STB)	Inactive	Error- and relay pre-alarm can be configured ⇒ Chapter 7.3.6	Error cases can be configured ⇒ Chapter 7.5.5 Error signal output ⇒ Chapter 7.5.6
Internal errors safety channel inactive again (STB)	Inactive Unlocking possible	Pre-alarm monitoring active ⇒ Chapter 7.3.4	Scaled analog signal is being output ⇒ Chapter 7.5
Internal errors safety channel after acknowledgement (STB)	Monitoring of the limit value active ⇒ Chapter 7.3.2		

15 SIL and PL



DAKS
Dachverband
der Anlagentechnischen
Dienstleistungen
D-26120A43-00

Certificate

No. SEBS-A.102606/16-1 V2.0

TÜV NORD Systems GmbH & Co. KG hereby certifies

JUMO GmbH & Co.KG

Moritz-Juchheim-Strasse 1
36039 Fulda

for the safety related products electronic safety temperature monitor/limiter

JUMO safetyM STB/STW 701150

meets the requirements listed in the below listed standards

- DIN EN 61508/-1/-2/-3:2011; SIL 3
- DIN EN 14597: 2015
- DIN EN IEC 60730-2-9: 2021
- DIN EN ISO 13849-1:2016, PL e

Certificationprogramm Leuchtechnik (SEBS-AE-SEECERT-VA-320-20, Rev. 5.14.19)

Base of certification is the report
SEBS-A.102606/16TB-1 and the
certificate tracking list in the valid
version.

Safety functions with capable SIL are
given in the certificate tracking list.
This certificate entitles the holder to use
the pictured Safety Approved mark.

Valid until: 2026-06-24

File reference: 8119036868

Hamburg, 2021-06-25

B. Platt
Bianca Platt

Certification Body SEECERT

TÜV NORD Systems GmbH & Co. KG
Große Bahnstraße 31, 22525 Hamburg, Germany





Tracking list, V4.0 of the temperature monitor/limiter

JUMO safetyM STB/STW 701150

Certificate-Nr.: SEBS-A.102606/16-1 VZ0

Product type list JUMO safetyM STB/STW 701150	Connected sensors (Architecture)	SFF	PFDAavg	PFH(I/M)
230V: JUMO safetyM STB/STW 701150	1 PT100 – two-wire-technology (1oo1)	96%	2,02e-4	4,56e-9
	2 PT 100/PT 1000 – two-wire-technology (1oo2)	96%	4,57e-5	1,05e-9
	2 PT 100/PT 1000 – three-wire-technology (1oo2)	96%	4,57e-5	1,05e-9
	2 Thermal element (1oo2)	96%	4,49e-5	1,03e-9
	1 PT 100/PT 1000 – (two- and three-wire technology)	96%	5,39e-5	1,22e-9
	1 Thermal element (1oo2)	96%	4,48e-5	1,04e-9
	STB/STW 701150 without sensors has a 1oo2D architecture, no sensing device, or use of 4, 20mA means that the sensing device is not included in the calculations	96%		
24V: JUMO safetyM STB/STW 701150	1 PT 100 – two-wire-technology (1oo1)	96%	2,91e-4	6,59e-9
	2 PT 100/PT 1000 – two-wire-technology (1oo2)	96%	1,35e-4	3,07e-9
	2 PT 100/PT 1000 – three-wire-technology (1oo2)	96%	1,35e-4	3,07e-9
	2 Thermal element (1oo2)	96%	1,37e-4	3,13e-9
	1 PT 100/PT 1000 – (two- and three-wire technology)	96%	1,41e-4	3,23e-9
	1 Thermal element (1oo2)	96%	1,41e-4	3,23e-9
	STB/STW 701150 without sensors has a 1oo2D architecture, no sensing device, or use of 4, 20mA means that the sensing device is not included in the calculations	96%	1,33e-4	3,05e-9

The JUMO safetyM STB/STW 701150 has the following mode of actions according to DIN EN 14697: 2B, 2D, 2F, 2K, 2L, 2V, 2X, 2F, -Software class C, Certification according to DIN EN 61506 and DIN EN ISO 15849 applies to devices with 0/1mA code 006.

	Release JUMO:	Release Assessor	Release Certification body:
Signature:			
Date:	2016-08-11	2016-08-11	2016-08-11

16 China RoHS

		有毒有害物质或元素 Hazardous substances					
部件名称							
Product group: 701150/701155							
		铅 (Pb)	汞 (Hg)	镉 (Cd)	六价铬 (Cr(VI))	多溴联苯 (PBB)	多溴二苯醚 (PBDE)
外壳 Housing (Gehäuse)		○	○	○	○	○	○
过程连接 Process connection (Prozessanschluss)		○	○	○	○	○	○
螺母 Nut (Mutter)		○	○	○	○	○	○
螺钉 Screw (Schraube)		○	○	○	○	○	○
<p>本表格依据 SJ/T 11364-2014的规定编制。 (This table is prepared in accordance with the provisions of SJ/T 11364-2014.) ○ : 表示该有害物质在该部件所有均质材料中的含量均在 GB/T 26572 规定的限量要求以下。 (○: Indicates that said hazardous substance contained in all of the homogeneous materials for this part is below the limit requirement of GB/T 26572.) X : 表示该有害物质至少在该部件的某一均质材料中的含量超出 GB/T 26572 规定的限量要求。 (X: Indicates that said hazardous substance contained in one of the homogeneous materials used for this part is above the limit requirement of GB/T 26572.)</p>							



JUMO GmbH & Co. KG

Street address:
Mortiz-Juchheim-Straße 1
36039 Fulda, Germany
Delivery address:
Mackenrodtstraße 14
36039 Fulda, Germany
Postal address:
36035 Fulda, Germany
Phone: +49 661 6003-0
Fax: +49 661 6003-607
Email: mail@jumo.net
Internet: www.jumo.net

JUMO Instrument Co. Ltd.

JUMO House
Temple Bank, Riverway
Harlow, Essex, CM20 2DY, UK
Phone: +44 1279 63 55 33
Fax: +44 1279 62 50 29
Email: sales@jumo.co.uk
Internet: www.jumo.co.uk

JUMO Process Control, Inc.

6724 Joy Road
East Syracuse, NY 13057, USA
Phone: +1 315 437 5866
Fax: +1 315 437 5860
Email: info.us@jumo.net
Internet: www.jumousa.com

