



Installation and operating manual

Universal display for 4-20 mA - transmitter

ab Version 1.0

GIA 0420 ... - ex



GIA ... VO - ex





GIA ... WKT - ex



GIA ... VOT - ex

CE
0158

-  Please read these instructions carefully before use!
-  Please consider the safety instructions!
-  Please keep for future reference!



WEEE-Reg.-Nr. DE 93889386

Index

1	GENERAL NOTE	2
2	DESIGNATED USE	3
2.1	INTENDED USE	3
2.2	SAFETY SIGNS AND SYMBOLS	3
2.3	SKILLED PERSONNEL	3
2.4	SAFETY GUIDELINES	4
2.5	EX PROTECTION	5
3	PRODUCT DESCRIPTION.....	5
3.1	SCOPE OF SUPPLY	5
3.2	FUNCTION DESCRIPTION	5
3.3	IDENTIFICATION	6
3.4	DISPLAY AND OPERATING ELEMENTS	6
4	ELECTRIC CONNECTION.....	7
4.1	GIA ... WK(T) - EX	7
4.1.1	Terminal assignment	7
4.1.2	Connection example for optionally switching output:	7
4.1.3	GIA 0420 WK(T) - ex / S1: Switching of a alarm device	7
4.2	GIA ... VO(T) - EX	8
4.2.1	Assignment of the angle-type plug	8
4.2.2	Adjustment of the connections of the GIA 0420 VO(T) - ex:	8
4.2.3	Example assignment for optionally switching output:	9
4.2.4	GIA 0420 VO(T) - ex / S1: Switching of a alarm device	9
5	CONFIGURATION.....	10
5.1	ADDITIONAL PARAMETER FOR OPTION / S1	11
6	SELECTION OF SWITCHING AND ALARM POINTS	12
7	OFFSET AND SLOPE ADJUSTMENT	13
8	MIN-/MAX- VALUE MEMORY	13
9	ERROR CODES	14
10	SPECIFICATIONS	15
11	DECOMMISSIONING, RESHIPMENT AND DISPOSAL	16
11.1	RESHIPMENT	16
11.2	DISPOSAL INSTRUCTIONS	16
ADDENDUM A: EC – DECLARATION OF CONFORMITY.....		17
ADDENDUM B: EC-TYPE EXAMINATION CERTIFICATE		18

1 General note

Read this document carefully and get used to the operation of the device before you use it. Keep this document within easy reach near the device for consulting in case of doubt.

2 Designated Use

2.1 Intended Use

The GIA 0420 VO(T) - ex and GIA 0420 WK(T) - ex are microprocessor controlled display devices for 4..20 mA input signals.

The device is suitable for use in potentially explosive atmospheres of group II, zone 1 and 2, temperature class T4 to T1 (according to IEC 60079-0).

The device must not be used in hazardous areas other than those mentioned above, in particular not in underground mines as well as in potentially explosive dust atmospheres. It should also be noted that the device is not suitable for applications which require the temperature classes T6 or T5.

The GIA 0420 ... - ex is optionally available with a electrically isolated switching output. The output switch and the switching device must be supplied from the same intrinsically safe circuit as the display GIA 0420 ... - ex.

The device may only be operated in combination with Ex-approved transmitters and intrinsically safe circuits in accordance with the connection data. The total capacitance and inductance of device GIA 0420 ... - ex, intrinsically safe transmitter, switching devices and wiring may not exceed the allowable for the intrinsically safe circuit totals.

To configure GIA 0420 VO - ex and GIA 0420 WK - ex the cover has to be removed to get access to the needed buttons. This may not be done in hazardous areas.

If the GIA 0420 ... - ex was operated on non-intrinsic circuits or if the permissible load values were exceeded, the device must not be used again in Ex applications.

Only technically qualified persons are permitted to carry out installation, commissioning, operation and decommissioning. The qualified personnel must have carefully read and understood the operating manual before beginning any work.

The liability and warranty of the manufacturer for damages and consequential damages are voided with misuse, disregard of this operating manual, assignment of inadequately qualified technical personnel and arbitrary modifications of the product.

2.2 Safety signs and symbols

Warnings are labelled in this document with the followings signs:



Caution!

This symbol warns of imminent danger, death, serious injuries and significant damage to property at non-observance



Caution!

This symbol indicates a potentially dangerous situation in explosion-prone areas that can result in death or severe injuries if it is not avoided.



Attention!

This symbol warns of possible dangers or dangerous situations which can provoke damage to the device or environment at non-observance.



Note!

This symbol point out processes which can indirectly influence operation or provoke unforeseen reactions at non-observance.













2.3 Skilled personnel

are persons who are familiar with the set-up, installation, commissioning and operation of the product and have appropriate qualification for their work. For example:

- Training or instruction and/or authorisation, power circuits and devices/systems in accordance with the standards of safety for activation, deactivation, disconnection, earthing and identification.
- Training or instruction in accordance with the standard of safety technology for care and use of suitable safety equipment.
- Knowledge about the installation of devices in explosion-prone areas.

2.4 Safety guidelines

This device has been designed and tested in accordance with the safety regulations for electronic devices. However, its trouble-free operation and reliability cannot be guaranteed unless the standard safety measures and special safety advises given in this manual will be adhered to when using the device.

1.  Requirements of Directive 2014/34/EU (ATEX) and IECex must be observed
The respective national regulations for Ex use must also be complied with (e.g. EN 60079-10 and EN 60079-14).
2.  Install the displaying device according to the manufacturer's specifications and the valid standards and regulations.
3.  The device may be connected to approved intrinsically safe circuits with his maximum values.
4.  For units with optional output switch, the output switch and the switching device must be supplied from the same intrinsically safe circuit as the GIA ...!
Only approved intrinsically safe switching devices may be used which correspond to the specified maximum values of the circuit. The total capacitance and inductance of the devices GIA ... (incl. switching output) and the switching devices, including the connection cable values, may not exceed the allowable for the intrinsically safe circuit totals. If concentrated inductances and capacitances exist, the manufacturer must be consulted for permission.
5.  Modifications or repairs of the device may not be performed by the customer.
For maintenance or repair the device must be sent to the manufacturer.
6.  The opening of the devices is only permitted outside the hazardous area.
7.  To configure GIA ... VO-ex and GIA ... WK-ex the cover has to be carefully removed to get access to the needed buttons. Exposed parts must not be damaged!
This has to be done only by trained personnel and with consideration of adequate ESD safety precautions.
Take care to insert the sealing correctly when reassemble the cover.
8.  The devices GIA ... VO(T) - ex meet the requirements of intrinsic safety only after angel plugs, which are appropriate to the required IP protection degree, are connected. The devices shall be installed in places that are protected against external damage.
9.  The devices back side (GIA ... VO(T) - ex and GIA ... WK - ex) may not be cleaned with a cloth or other means, which can generate an electrostatic charge.
10.  Trouble-free operation and reliability of the device can only be guaranteed if the device is not subjected to any other climatic conditions than those stated under "Specification".
ATTENTION
11.  When connecting the device to other devices (e.g. PC) the interconnection has to be designed most thoroughly as internal connections in third-party devices (e.g. connection GND with protective earth) may lead to undesired voltage potentials.
ATTENTION
12.  If there is a risk whatsoever involved in running it, the device has to be switched off immediately and to be marked accordingly to avoid re-starting.
DANGER
Operator safety may be a risk if:
 - there is visible damage to the device.
 - the device is not working as specified.
 - the device has been stored under unsuitable conditions for a longer time.
 In case of doubt, please return device to manufacturer for repair or maintenance.
13.  Do not use these products as safety or emergency stop devices or in any other application where failure of the product could result in personal injury or material damage.
DANGER
Failure to comply with these instructions could result in death or serious injury and material damage.

2.5 Ex protection

1. The device may be connected to approved intrinsically safe circuits with the following maximum values:

GIA 0420 ... - ex:

$U_i = 28 \text{ V DC}$

$I_i = 100 \text{ mA}$

$P_i = 1.2 \text{ W}$

$C_i \leq 13 \text{ nF}$

$L_i = \sim 0 \text{ }\mu\text{H}$

Additional for the switching output (only at option "switching output")

$C_i \leq 4.5 \text{ nF}$

$L_i = \sim 0 \text{ }\mu\text{H}$

3 Product description

3.1 Scope of supply

- display device
- each 1 erection crew M3 x 68, M3 x 75 (only for GIA ... VO)
- mounting and operating manual

3.2 Function description

The GIA 0420 VO(T) - ex and GIA 0420 WK(T) - ex are microprocessor controlled display devices.



The different design types of the device have an input for:

- standard signal 4 – 20 mA

The measuring value is displayed on a 4-digit LCD display with max. display area ranging from -1999 to +9999 digits.

The device optionally features a switching output (NPN-output) which can be configured as 2-point controller or min-/max alarm. The state of the output is displayed with an arrow at the LCD.

The GIA 0420 ... is designed for the connection of any measuring transducers (with a 4 to 20 mA output). This design type doesn't need an auxiliary supply as it is supplied by the measuring current.

Parameter and limit values are entered via three keys which are accessible after removal of the cover (design type VO and WK).

Devices of the design type VOT and WKT have that keys freely accessible at top of the device.

The operating range of the display device can be directly adjusted to the transmitter without any additional accessories by simply entering the maximum and minimum measuring range limits as well as the decimal point position.

All programmable parameters of the device are saved in an EEPROM. In case of a current failure they will remain there for at least 10 years. The device is equipped with a self-diagnosis system continuously monitoring the essential parts of the device for their perfect functioning. Both the self-diagnosis and the measuring sensor monitoring for values exceeding or falling below permissible limits ensure maximum operational reliability of the device.

However, prior to you starting your operation make sure to configure the device for your application. Please also refer to chapter "Configuration".

3.3 Identification

Examples for type plates

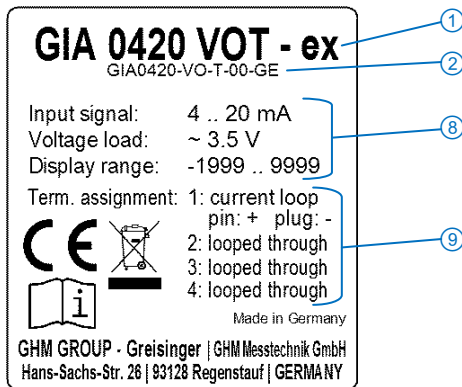

- ① Device type
- ② Variante code
- ③ Approval number
- ④ Ex identification
- ⑤ Code for month/year of manufacture: MY
M: A = January, B = February, ..., L = December
Y: Q = 2016, R = 2017, S = 2018, ..., Z = 2025
(Example: CR = March 2017)
- ⑥ Serial number

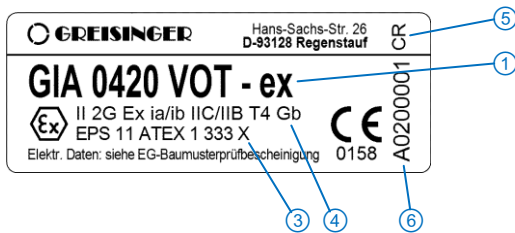

- ⑧ Information to measuring input (refer to chap. 10)
- ⑨ Information to assignment (refer to chap. 4)
-  Disposal note (refer to chap. 11.2)



Please refer to manual:
Read the mounting- and operating manual carefully,
before you connect and use the device

3.4 Display and operating elements

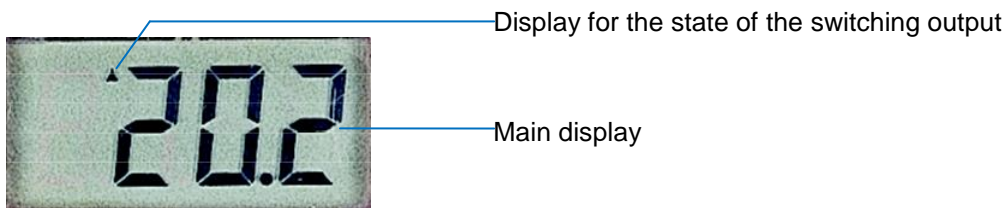

Button 1, >2s: activates menu "switching points ..." (refer to chap.6)
(only available for devices with option S1)
In menu: **save value or step** to next parameter



Button 2, short display max. value
Button 2, >2s: activates configuration menu (refer to chap. 8)
Button 2 + 3, >2s: reset min-/max. value
In menu: press short= increase value.
press long = roll-function with overflow-function.*)



Button 3, short display min. value
Button 2, >2s: activates offset/slope menu " (refer to chap. 7)
Button 2 + 3, >2s: reset min-/max. value
In menu: press short= increase value.
press long = roll-function with overflow-function.*)

*) The input is made with the buttons 2 and 3. When pressing the button once the value will be raised (button 2) by one or lowered (button 3) by one.
When holding the button pressed for longer than 1 sec. the value starts counting up or down, the counting speed will be raised after a short period of time.
The device also features a 'overflow-function', when reaching the upper limit of the range, the device switches to the lower limit, vice versa.

4 Electric connection

4.1 GIA ... WK(T) - ex

The connection of the GIA ... WK - ex occurs via 2- or 4-wire connection cable.

Supply voltage: device takes power from measuring current

Electric connection and commissioning of the device must be carried out by trained and skilled personnel.

Wrong connection may lead to the destruction of the display device, in which case we cannot assume any warranty!

! Mind the maximum input current rating of 40mA under any circumstances !

4.1.1 Terminal assignment

connection number	wire colour	GIA 0420 WK(T) - ex	GIA 0420 WK(T) - ex / S1 (with switching output)
1	white	signal +	signal +
2	brown	signal -	signal -
3	green	---	switching output +
4	yellow	---	switching output -

4.1.2 Connection example for optionally switching output:

Please note: The max. permitted voltage and switching current of the switching output must not be exceeded (even not for a short time).

Attention: *The measuring and switching branches have to be supplied by the same intrinsically safe current circuit. The total capacity and inductivity of GIA..., intrinsically safe transducer, intrinsically safe switching device and cabling have to meet the limit values of the supply device.*

Example for permitted connection values of switching devices/cabling if the universal isolating amplifier **ST 500 Ex - 10 - ..** and the 4-20mA transducer **IS-20 S** or **GITT 01 - ex** is used:

Connection values of the ST 500 for ia/IIC: $C_o = 47 \text{ nF}$, $L_o = 2 \text{ mH}$

for ia/IIB: $C_o = 370 \text{ nF}$, $L_o = 15 \text{ mH}$

	Pressure transmitter IS-20 S	Temperature transmitter GITT 01 - ex
Connection values transmitter:	$C_i < 22 \text{ nF}$, $L_i = 0 \text{ mH}$	$C_i = 0 \text{ nF}$, $L_i = 0 \text{ mH}$
Remaining values for switching device/cabling if GIA 0420 is used:	for ia/IIC: $C_i < 7.5 \text{ nF}$ ($47 \text{ nF} - (13 + 4.5 + 22) \text{ nF}$) $L_i < 2 \text{ mH}$ ($2 \text{ mH} - (0 + 0) \text{ mH}$) for ia/IIB: $C_i < 330 \text{ nF}$ ($370 \text{ nF} - (13 + 4.5 + 22) \text{ nF}$) $L_i < 15 \text{ mH}$ ($15 \text{ mH} - (0 + 0) \text{ mH}$)	for ia/IIC: $C_i < 29.5 \text{ nF}$ ($47 \text{ nF} - (13 + 4.5 + 0) \text{ nF}$) $L_i < 2 \text{ mH}$ ($2 \text{ mH} - (0 + 0) \text{ mH}$) for ia/IIB: $C_i < 352 \text{ nF}$ ($370 \text{ nF} - (13 + 4.5 + 0) \text{ nF}$) $L_i < 15 \text{ mH}$ ($15 \text{ mH} - (0 + 0) \text{ mH}$)

4.1.3 GIA 0420 WK(T) - ex / S1: Switching of a alarm device

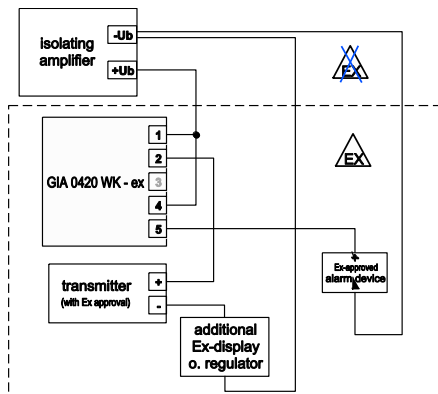

4.2 GIA ... VO(T) - ex

To connect the GIA...VO it is simply plugged into an existing transmitter by means of a special adapter for the cubic plug according to DIN EN 175301-803 A (ex. DIN43650 A).

Supply voltage: device takes power from measuring current

Electric connection and commissioning of the device must be carried out by trained and skilled personnel.

*Wrong connection may lead to the destruction of the display device, in which case we cannot assume any warranty!
! Mind the maximum input current rating of 40mA under any circumstances!*

4.2.1 Assignment of the angle-type plug

Standard assignment of the angle-type plug:

contact number	wire colour (socket contact)	Device design type			
		GIA 0420 VO(T) - ex		GIA 0420 VO(T) - ex / S1	
		pin	socket	pin	socket
1	grey	GIA.. +	GIA.. -	GIA.. +	GIA.. -
2	red	connected		connected	
3	black	connected		switching output +	n.c.
4	yellow	connected		switching output -	n.c.

n.c. = non connected

4.2.2 Adjustment of the connections of the GIA 0420 VO(T) - ex:

Pin 2 of the elbow-type plug is directly connected with the socket.
The GIA 0420 VO(T) - ex is between pin 1 (+) and socket contact 1 (-).
Pin 3 and 4 are directly connected to the socket or are used for the switching output in case of the option with switching output.

If the 'Signal/GND'-line in your transmitter is not assigned to contact 2 and if the '-Ub'-line is not assigned to contact 1, please do not forget to adjust the GIA..-angle-type plug and the external angle-type plug accordingly:

To do so open the GIA..-angle-type plug (refer to the "general instructions for change" on the next page) and exchange the wire of contact 1 and contact 2 against the wire of the contact representing the connection in your transmitter. Then exchange and rewire the two contacts in the angle-type plug of your connecting cable.

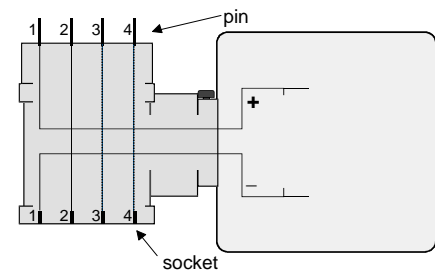

assignment of GIA 0420 VO(T) - ex (standard)

General instructions for change of the angle-type plug assignment:

Remove the coupling insert by means of a screw driver at the position indicated (arrow).

Change the assignment according the notes of the respective input signal.

Latch coupling insert in cover. You have a choice between 4 different orientations – each of them spaced 90°.

Put on angel-type plug and connect plugs using the long screw delivered (do not forget seals).

4.2.3 Example assignment for optionally switching output:

Please note: The max. permitted voltage and switching current of the switching output must not be exceeded (even not for a short time).

Attention: *The measuring and switching branches have to be supplied by the same intrinsically safe current circuit. The total capacity and inductivity of GIA..., intrinsically safe transducer, intrinsically safe switching device and cabling have to meet the limit values of the supply device.*

Example for permitted connection values of switching devices/cabling if the universal isolating amplifier **ST 500 Ex - 10 - ..** and the 4-20mA transducer **IS-20 S** is used:

Connection values of the ST 500 for ia/IIC: $C_o = 47 \text{ nF}$, $L_o = 2 \text{ mH}$
 for ia/IIB: $C_o = 370 \text{ nF}$, $L_o = 15 \text{ mH}$

Pressure transmitter IS-20 S in conjunction with GIA 0420 ...	
Connection value transmitter:	$C_i < 22 \text{ nF}$, $L_i = 0 \text{ mH}$
Remaining values for switching device/cabling:	for ia/IIC: $C_i < 7.5 \text{ nF}$ ($47 \text{ nF} - (13 + 4.5 + 22) \text{ nF}$) $L_i < 2 \text{ mH}$ ($2 \text{ mH} - (0 + 0) \text{ mH}$)
	for ia/IIB: $C_i < 330 \text{ nF}$ ($370 \text{ nF} - (13 + 4.5 + 22) \text{ nF}$) $L_i < 15 \text{ mH}$ ($15 \text{ mH} - (0 + 0) \text{ mH}$)

4.2.4 GIA 0420 VO(T) - ex / S1: Switching of a alarm device

Attention: *The measuring and switching branches have to be supplied by the same intrinsically safe current circuit!*

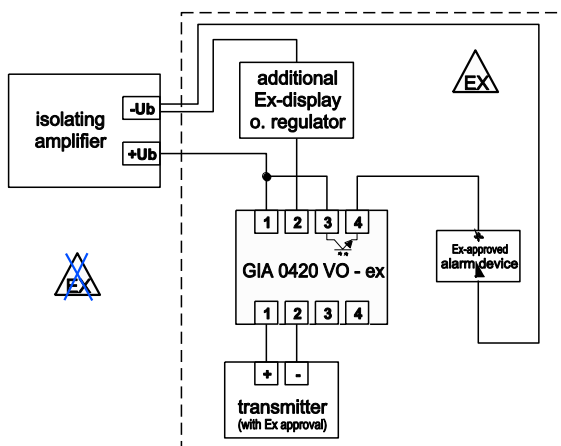

5 Configuration

Note: To configure GIA ... VO - ex and GIA ... WK - ex the cover has to be removed carefully to get access to the needed buttons.

Take care of adequate ESD safety precautions to prevent damage to the exposed parts!

!!! Important: The device must not be open in Ex-area !!!

Please note: measuring current should be at least 4mA during configuration!

Follow these instructions to configure the device:

- Press **button 2** for 2 seconds during actual value display, „dP“ is displayed.
- Set parameter value with **button 2** and **button 3**.
- Save the set with **button 1**, the parameter name is displayed again.
- Proceed to the next parameter with **button 1**, the name of that parameter is displayed.

If there is no key pressed within 60 seconds the configuration is cancelled.

The settings already entered are lost.

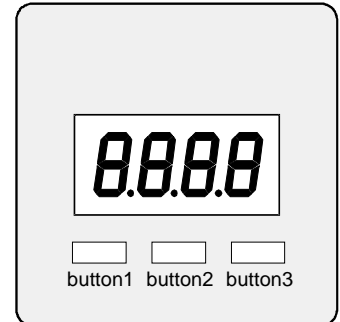

Parameter	Value	Description
Button 1	Button 2 and 3	
dP	Position of decimal point	
	----	Max. display range: -1999 ... 9999
	---.	Max. display range: -199.9 ... 999.9
	--.---	Max. display range: -19.99 ... 99.99
	-.---	Max. display range: -1.999 ... 9.999
d _i .Lo	Lower display range limit (display low)	
	-1999 ... 9999	This value is displayed for input signal = 4mA.
d _i .Hi	Upper display range limit (display high)	
	-1999 ... 9999	This value is displayed for input signal = 20mA.
L	(Measuring range) limit	
	oFF	deactivated: Exceeding of the measuring range limit is tolerable as long as value is within measuring range (p.r.t. note).
	on.Er	active, (display error): The measuring range limit is exactly bounded by the input signal. When exceeding or short falling the input signal the device will display an error message.
	on.rL	active, (display measuring range limit): The measuring range limit is exactly bounded by the input signal. When exceeding or short-falling the input signal the device will display the selected lower/upper display value. <i>e.g. humidity: when shortfalling or exceeding, the device will display 0% or 100%.</i>
	<i>Note:</i> When exceeding the measuring range, the device will always display an error message (.Err.1. or .Err.2.) independent of the current limit settings. The measuring range is from approx 3,7 and 20,8 mA.	
FILT	Filter	
	oFF	Filter deactivated
	0.1 ... 2.0	Filter active: Prevents "jumping" of the last digit and filters short noise pulses. Higher numbers imply stronger filtering <i>Attention: this causes higher response times of the switching functions!</i>

The configuration is done at this point for devices without option "switching output". Press **button 1** one more time after the input of the last parameter to close the configuration menu. The devices restarts (segment test).

5.1 Additional parameter for option / S1

The adjustment of the switching and alarm points follows the filter setting. The following points are added to the configuration menu:

outP	Output function	
	<i>no</i>	No output, device used as display
	<i>2P</i>	2-point-controller
	<i>ALFi</i>	Min- / max- alarm, together

Depending on the selected output function further parameters have to be adjusted. The configuration menu automatically skips parameters not needed for the selected output function. The following diagram shows which parameters are successively displayed for each output function.

A description of the single parameters follows afterwards.

Parameter	Value	Description
Button 1	Button 2 and 3	
<i>1.on</i> only at outP = 2P	Switch-on point of output 1	
	<i>d₁.Lo ... d₁.Hi</i>	Value at which output 1 should be switched on. Value has to be between upper and lower measuring range limit set at the beginning of the configuration menu.
<i>1.off</i> only at outP = 2P	Switch-off point of output 1	
	<i>d₁.Lo ... d₁.Hi</i>	Value at which output 1 should be switched off. Value has to be between upper and lower measuring range limit set at the beginning of the configuration menu.
<i>1.dEL</i> only at outP = 2P	Delay of switching function of output 1	
	<i>0.0 ... 999.9</i>	The set value is the time [in seconds] the device waits at least after switching-off output 1 to switch it on again.
<i>1.Err</i> only at outP = 2P	Preferred position of output 1	
	<i>on, off</i>	If an error occurs, the device switches output 1 to "active" (on) or "inactive" (off)
<i>ALHi</i> only at outP = ALFi	Max-alarm point	
	<i>ALLo ... d₁.Hi</i>	Value, at which max-alarm should be triggered. Value has to be between upper and lower measuring range limit set at the beginning of the configuration menu.
<i>ALLo</i> only at outP = ALFi	Min-alarm point	
	<i>d₁.Lo ... ALHi</i>	Value, at which min-alarm should be triggered. Value has to be between upper and lower measuring range limit set at the beginning of the configuration menu.
<i>A.dEL</i> only at outP = ALFi	Alarm delay	
	<i>0 ... 999.9</i>	The set value is the alarm delay in seconds. The alarm case has to last for the set time to trigger the alarm.

After having set and confirmed the last point (depending on the selected output function) the configuration is done.

Press **button 1** one more time after the input of the last parameter to close the configuration menu.

The devices restarts (segment test).

6 Selection of switching and alarm points

Only at option switching output (GIA ... - ex / S1):

Note: All relevant switching and alarm points can be set at this menu.
(Preferred output position and delay of the output can only be set at configuration menu)
Depending on the selected output function different parameters have to be adjusted.
The configuration menu automatically skips parameters not needed for the selected output function.

Note: **menu cannot be called if output function is set off or at devices without option switching output**

Follow these instructions to adjust switching and alarm points:

- Press **button 1** for 2 seconds during actual value display, „1.on“ or „AL.Hi“ is displayed.
- Set parameter value with **button 2** and **button 3**.
- Save the set with **button 1**, the parameter name is displayed again.
- Proceed to the next parameter with **button 1**, the name of that parameter is displayed.

If there is no key pressed within 60 seconds the configuration is cancelled.
The settings already entered are lost.

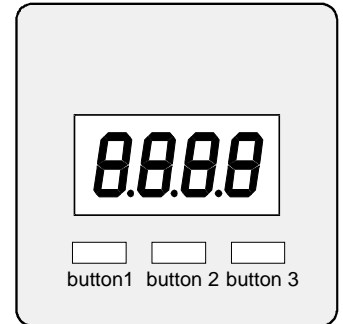

Parameter	Value	Description
Button 1	Button 2 and 3	
1.on only at outP = ZP	Switch-on point of output 1	
	$d_i . Lo \dots d_i . Hi$	Value at which output 1 should be switched on. Value has to be between upper and lower measuring range limit set at the beginning of the configuration menu.
1.off only at outP = ZP	Switch-off point of output 1	
	$d_i . Lo \dots d_i . Hi$	Value at which output 1 should be switched off. Value has to be between upper and lower measuring range limit set at the beginning of the configuration menu.
AL.Hi only at outP = ALFi	Max-alarm point	
	$ALLo \dots d_i . Hi$	Value, at which max-alarm should be triggered. Value has to be between upper and lower measuring range limit set at the beginning of the configuration menu.
AL.Lo only at outP = ALFi	Min-alarm point	
	$d_i . Lo \dots ALHi$	Value, at which min-alarm should be triggered. Value has to be between upper and lower measuring range limit set at the beginning of the configuration menu.
A.dEL only at outP = ALFi	Alarm delay	
	$0 \dots 9999$	The set value is the alarm delay in seconds. The alarm case has to last for the set time to trigger the alarm.

After having set and confirmed the last point (depending on the selected output function) the configuration is done.

Press **button 1** one more time after the input of the last parameter to close the configuration menu. The devices restarts (segment test).

7 Offset and slope adjustment

The offset and slope-adjustment function can be used for compensating the tolerance of the used sensor, resp. for vernier adjustment of the used transducer / transmitter.

Follow these instructions to run the offset and slope adjustment of the device:

- Press **button 3** for 2 seconds during actual value display, „OFFS“ is displayed.
- Set parameter value with **button 2** and **button 3**.
- Save the set with **button 1**, the parameter name is displayed again.
- Proceed to the next parameter with **button 1**, the name of that parameter is displayed.

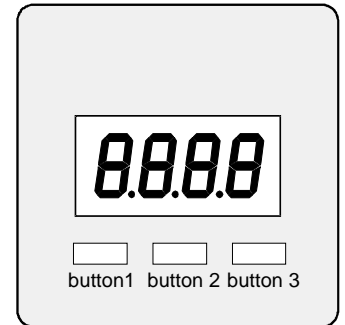

Parameter	Value	Description
Button 1	Button 2 and 3	
oFFS	Offset	
	-5.00 ... 5.00	The offset in digit The set offset value is subtracted from measured value.
ScAL	Scale	
	-5.00 ... 5.00	The scale in %. The displayed value is calculated according to the following formula: Display = (measured value - offset - di.Lo) * (1 + slope adjustment [% / 100]) + di.Lo

Example for offset and slope adjustment:

Connection of pressure transmitter.

The device displays without offset and slope adjustment: at 0 bar = 0.08, at 20 bar = 20.02

From this calculated:

offset:	0.08
slope:	$20.02 - 0.08 = 19.94$
difference:	0.06 (= ideal slope - actual slope = 20.00 - 19.94)

Therefore this values should be set:

offset =	0.08
scale =	0.30 (= difference / actual slope = 0.06 / 19.94 = 0.0030 = 0.30%)

8 Min-/max- value memory

The device features a minimum/maximum-value storage. In this storage the highest and lowest performance data is saved.

Calling of the minimum value:

Press button 3 shortly: the device will display "Lo" briefly, after that the min-value is displayed for about 2 sec.

Calling of the maximum value:

Press button 2 shortly: the device will display "Hi" briefly, after that the max-value is displayed for about 2 sec.

Erasing of the min/max values:

Press button 2 and 3 for 2 sec.: The device will display "CLr" briefly, after that the min/max-values are set to the current displayed value.

9 Error Codes

When detecting an operating state which is not permissible, the device will display an error code. The following error codes are defined:

Err.1: Exceeding of measuring range

Indicates that the valid measuring range of the device has been exceeded.

Possible causes:

- Input signal too high
- Sensor shorted (at 0(4)-20mA)

Remedies:

- The error-message will be reset if the input signal is within the limits.
- Check transmitter and device configuration (e.g. input signal).

Err.2: Values below measuring range

Indicates that the values are below the valid measuring range of the device.

Possible causes:

- Input signal is too low or negative
- Current below 4mA
- Sensor broken (at 4-20mA)

Remedies:

- The error-message will be reset if the input signal is within the limits.
- Check transmitter and device configuration (e.g. input signal).

Err.3: Display range has been exceeded

Indicates that the valid display range (9999 digit) of the device has been exceeded.

Possible causes:

- Incorrect scale

Remedies:

- The error-message will be reset if the display value is below 9999.

Err.4: Values below display range

Indicates that display value is below the valid display range of the device (-1999 digit).

Possible causes:

- Incorrect scale

Remedies:

- The error-message will be reset if the display value is above -1999.

Err.7: System error

The device features an integrated self-diagnostic-function which checks essential parts of the device permanently. When detecting a failure, error-message Err.7 will be displayed.

Possible causes:

- Actual temperature is below / above the valid temperature range
- Device defective

Remedies:

- Stay within valid temperature range
- Exchange the defective device.

Er.11: Value could not be calculated

Indicates a measuring value, needed for calculation of the display value, is faulty or out of range.

Possible causes:

- Incorrect scale

Remedies:

- Check settings and input signal

10 Specifications

Input signal:	4 ... 20 mA (2-wire)
Voltage load:	3.0 – 3.5 V (typ.)
max. permissible input:	25 mA (40mA short time)
Supply current:	from current loop
Display:	approx. 10 mm high LCD-display
Display range:	limits freely adjustable
Max. display value:	9999 digit
Min. display value:	-1999 digit
Recommended range:	≤ 2000 digit
Decimal point:	any position
Accuracy: (at 25°C)	< 0.2% ±1 digit
Temperature drift:	< 100 ppm / K
Measuring range:	approx. 5 measurements / second
Filter:	adjustable
Operation:	via 3 buttons (at ..VO and ..WK the cover has to be removed)
Min-/max-value memory:	callable via buttons
Switching output: (optional)	
GIA 0420 VO(T) - ex / S1:	1 electrically isolated open collector output, Test voltage: 50 V
GIA 0420 WK(T) - ex / S1:	1 electrically isolated open collector output, Test voltage: 50 V
Switching point, hysteresis:	freely adjustable
Switching voltage:	max. 28 V
Switching current:	max. 50 mA - <i>Please note: the switching output is not short-circuits protected</i>
Reaction time:	≤ 250 ms
Connection output:	via angle-type plug (GIA ... VO...) or via connection cable (GIA ... WK...)
Nominal temperature:	25 °C
Working conditions:	-20 ... 50 °C, 0 ... 80 % (non condensing)
Connection: GIA ... VO...	special-adapter design for cubic plug according to EN 175301-803 A (ex. DIN43650 A) simple plug-in. 2 screws (68 and 75 mm) included in scope of supply (needed length depends on height of cubic plug)
GIA ... WK...	2- or 3- respect. 4- or 5-wire cable, approx. 2 m long
Housing:	ABS, front screen made of polycarbonate and plastic foil keyboard approx. 48.5 x 48.5 x 35.5 mm (L x W x H) without cubic plug and cable gland approx. 50.5 x 90 x 39.5 mm (L x W x H) with cubic plug
Protection rating: GIA ... VO...	IP65 (when cubic plug mounted appropriately)
GIA ... WK...	IP65 (IP00 for open cable ends of connection cable)
Directives and standards:	The instruments confirm to following European Directives: 2014/34/EU ATEX Directive 2014/30/EU EMC Directive 2011/65/EU RoHS Applied harmonized standards: EN 60079-0 : 2014 (EN 60079-0 : 2012 + A11:2013) EN 60079-11 : 2012 EN 61326-1 : 2013 emissions level: class B emi immunity according to table 2 Additional fault: <1 %
<i>When connecting long leads adequate measures against voltage surges have to be taken.</i>	

Addendum A: EC – Declaration of Conformity

GREISINGER

Member of GHM GROUP



EU-KONFORMITÄTSERKLÄRUNG EU-DECLARATION OF CONFORMITY

GHM GROUP - Greisinger | GHM Messtechnik GmbH | Hans-Sachs-Str. 26 | 93128 Regenstauf | GERMANY

Dokument-Nr. / Monat.Jahr: **1038 / 04.2017**
Document-No. / Month.Year:

Wir erklären hiermit unter alleiniger Verantwortung, dass die folgenden Produkte konform sind mit den Schutzziele der Richtlinie des Europäischen Parlaments:

We declare herewith under our sole responsibility that the following products are in compliance with the protection requirements defined in the European Council directives:

Produktbezeichnung: **GIA 0420 VO(T) - ex, GIA 0420 WK(T) - ex,
 GIA 010 VO(T) - ex, GIA 010 WK(T) - ex**
Product identifier:

Produktbeschreibung: **Universal-Anzeige
 (Universal displaying device)**
Product description:

Die Produkte entsprechen den folgenden Europäischen Richtlinien:
The products conforms to following European Directives:

Richtlinien / Directives	
2014/30/EU	EMV Richtlinie / EMC Directive
2014/34/EU	ATEX / ATEX
2011/65/EU	RoHS / RoHS

Angewandte harmonisierte Normen oder angeführte technische Normen:
Applied harmonized standards or mentioned technical specifications:

Harmonisierte Normen / harmonized standards	
EN 61326-1 : 2013	Allgemeine EMV Anforderungen / General EMC requirements
EN 60079-0 : 2014 (EN 60079-0 : 2012 + A11:2013)	Allgemeine ATEX Anforderungen / General ATEX requirements
EN 60079-11 : 2012	Geräteschutz durch Eigensicherheit "i" / Protection by intrinsic safety "i"
EN 50581 : 2012	Beschränkung der gefährlichen Stoffe / Restriction of hazardous substances

Diese Erklärung wird verantwortlich für den Hersteller abgegeben durch:
The manufacturer is responsible for the declaration released by:

Roland Bäuml

Standortleiter
Site Director

Regenstauf, 13. April 2017

Diese Erklärung bescheinigt die Übereinstimmung mit den genannten Harmonisierungsrechtsvorschriften, beinhaltet jedoch keine Zusicherung von Eigenschaften

This declaration certifies the agreement with the harmonization legislation mentioned, contained however no warranty of characteristics.

Addendum B: EC-Type Examination Certificate



EU - Type Examination Certificate

- (1) **EU - Type Examination Certificate**
- (2) Equipment and protective systems intended for use in potentially explosive atmospheres – **Directive 2014/34/EU**
- (3) EU - Type Examination Certificate Number
EPS 11 ATEX 1 333 X **Revision 1**
- (4) Equipment: GIA 0420 WK - ex, GIA 0420 WKT - ex, GIA 0420 VO - ex, GIA 0420 VOT - ex,
GIA 010 WK - ex, GIA 010 WKT - ex, GIA 010 VO - ex, GIA 010 VOT - ex,
GIA 0420 N - ex, GIA 010 N - ex
- (5) Manufacturer: GHM Messtechnik GmbH
- (6) Address: **GHM GROUP - Greisinger**
GHM Messtechnik GmbH
Hans-Sachs-Straße 26
93128 Regenstauf
Germany
- (7) This equipment and any acceptable variation thereto are specified in the annex to this certificate and the documentation therein referred to.
- (8) Bureau Veritas Consumer Products Services Germany GmbH, notified body No. 2004 in accordance with Article 21 given in the Directive 2014/34/EU of the European Parliament and of the Council of 26 February 2014, certifies that this equipment has been found to comply with the essential health and safety requirements relating to the design and construction of equipment and protective systems intended for use in potentially explosive atmospheres, given in Annex II of the Directive. The examination and test results are recorded in the confidential documentation under the reference number 09TH0409.
- (9) Compliance with the essential health and safety requirements has been assured by compliance with:
EN 60079-0:2012+A11:2013 **EN 60079-11:2012**
- (10) If the sign "X" is placed after the certificate number, it indicates that the equipment is subject to special conditions for safe use specified in the annex to this certificate.
- (11) This EU - Type Examination Certificate relates only to the design and examination of the specified equipment in accordance with Directive 2014/34/EU. Further requirements of this Directive apply to the manufacture of this equipment and its placing on the market. Those requirements are not covered by this certificate.
- (12) The marking of the equipment shall include the following:

 II 2G Ex ia/ib IIC/IIB T4 Gb

Certification department of explosion protection

Nuremberg, 2017-04-10



H. Schaffer

Page 1 of 3

Certificates without signature and seal are void. This certificate is allowed to be distributed only if not modified. Extracts or modifications must be authorized by Bureau Veritas Consumer Products Services Germany GmbH. EPS 11 ATEX 1 333 X, Revision 1.



**BUREAU
VERITAS**



Annex

(13)

(14) **EU - Type Examination Certificate EPS 11 ATEX 1 333 X****Revision 1**(15) Description of equipment:

The device GIA 0420 ... - ex is an indicator for the electrical standard current signal 4 – 20 mA without auxiliary power supply. The device GIA 010... - ex is an electric indicator for the electrical standard voltage signal 0 – 10 V. Both variants have an optional switching output for the connection of suitable relays or signaling devices. The device is manufactured in various versions:

VOT	GIA 0420 VOT - ex	Two-wire circuit 4-20 mA, case with adapter for an angle plug for easy connection in between. Push-button accessible from outside
	GIA 010 VOT - ex	Three-wire circuit 0-10 V, case and push-button as GIA 0420 VOT - ex.
VO	GIA 0420 VO - ex	Two-wire circuit 4-20 mA, case as GIA 0420 VOT – ex, push-button inside
	GIA 010 VO - ex	Three-wire circuit 0-10 V, case as GIA 0420 VOT - ex, push-button inside
WKT	GIA 0420 WKT - ex	Two-wire circuit 4-20 mA, case with cable tail, push-button accessible from outside
	GIA 010 WKT - ex	Three-wire circuit 0-10 V. case and push-button as GIA 0420 WKT - ex
WK	GIA 0420 WK - ex	Two-wire circuit 4-20 mA, case as GIA 0420 WKT - ex, push-button inside
	GIA 010 WK - ex	Three-wire circuit 0-10 V, case as GIA 0420 WKT - ex, push-button inside
N	GIA 0420 N - ex	Two-wire circuit 4-20 mA, case for installation in switching cabinets, connection via screw and plug terminals
	GIA 010 N - ex	Three-wire circuit 0-10 V, case and connection as GIA 0420 N - ex

Page 2 of 3

Certificates without signature and seal are void. This certificate is allowed to be distributed only if not modified. Extracts or modifications must be authorized by Bureau Veritas Consumer Products Services Germany GmbH, EPS 11 ATEX 1 333 X, Revision 1.



**BUREAU
VERITAS**



Electrical data:

The device may be connected to approved intrinsically safe circuits with the following maximum values:

GIA 0420 ... - ex	GIA 010 ... - ex
$U_i = 28 \text{ V DC}$	$U_i = 28 \text{ VDC}$
$I_i = 100 \text{ mA}$	$I_i = 100 \text{ mA}$
$P_i = 1,2 \text{ W}$	$P_i = 0,95 \text{ W}$
Inner Kap.: $C_i < 13 \text{ nF}$	Inner Kap.: $C_i < 26 \text{ nF}$
Inner Ind.: $L_i \sim 0 \text{ }\mu\text{H}$	Inner Ind.: $L_i \sim 0 \text{ }\mu\text{H}$
U_i, I_i, P_i also apply to the circuit output with $C_i < 4,5 \text{ nF}, L_i \sim 0 \text{ }\mu\text{H}$	

(16) Reference number: 09TH0409

(17) Special conditions for safe use:

For all variants:

For units with optional output switch, the output switch and the switching device must be supplied from the same intrinsically safe circuit as the indicator GIA.

Only approved intrinsically safe switching devices may be used which correspond to the specified maximum values of the circuit. The total capacitance and inductance of the devices GIA ... and the switching devices, including the values, may not exceed the allowable for the intrinsically safe circuit totals. If concentrated inductances and capacitances exist, the manufacturer must be consulted for permission.

Modifications or repairs of the device may not be performed by the customer. For maintenance or repair the device must be sent to the manufacturer.

Especially for the variants VO, VOT and WK, WKT:

The opening of the device is only permitted outside the hazardous area.

The setting of the inner keys (VO, WK) may be performed only by trained personnel.

The devices VO, VOT meet the requirements of intrinsic safety only after angle plugs, which are appropriate to the required IP protection degree, are connected. The devices shall be installed in places that are protected against external damage.

The devices back side (VO, VOT, WK, WKT) may not be cleaned with a cloth or other means, which can generate an electrostatic charge.

Especially for the variant N:

The device GIA... N – ex meet the requirements of intrinsic safety only after it is built in an appropriate device, which conforms with the necessary IP protection degree.

(18) Essential health and safety requirements:

Met by compliance with standards.

Certification department of explosion protection

Nuremberg, 2017-04-10

H. Schäffer

1828

Page 3 of 3

Certificates without signature and seal are void. This certificate is allowed to be distributed only if not modified. Extracts or modifications must be authorized by Bureau Veritas Consumer Products Services Germany GmbH, EPS 11 ATEX 1 333 X, Revision 1.